

CONTENT GENERATION UNDER EDUSAT PROGRAMME

**GENERATION
TRANSMISSION
&
DISTRIBUTION
(EET-403)**

Contributors:-

- 1. Sri S.R. Mohanty, Lect. (Elect), G. P. Kendrapara.**
- 2. Sri Prasanjit Das, Lect. (Elect), B.O.S.E., Cuttack.**
- 3. Smt. Snehalata Samal, Lect. (Elect), B.O.S.E., Cuttack.**

INDEX

<u>SL. NO.</u>	<u>TOPICS</u>	<u>PAGE NO.</u>
1	GENERATION OF ELECTRICITY	1 to 14
2	TRANSMISSION OF ELECTRIC POWER	15 to 20
3	OVER HEAD LINE	21 to 29
4	PERFORMANCE OF SHORT & MEDIUM LINES	30 to 41
5	EHV TRANSMISSION	42 to 46
6	DISTRIBUTION SYSTEM	47 to 55
7	UNDERGROUND CABLE	56 to 66
8	ECONOMICS ASPECTS	67 to 78
9	TYPES OF TARIFF	79 to 82
10	SUBSTATION	83 to 87

CHAPTER-1

GENERATION OF ELECTRICITY

HYDRO ELECTRIC POWER PLANT

Hydro Electric Power – The power obtained from Energy of Falling water is Known as hydro Electric Power.

HYDRO ELECTRIC POWER PLANT:

The power Plant Which generates Electrical Energy by utilizing the potential energy of water at high level called hydro electric power plant i.e. the potential energy stored in water is converted to kinetic energy again that Kinetic Energy is converted to Mechanical energy by allowing water through hydraulic turbine runner & finally mechanical energy is used to run generators OR alternator, Which coupled with turbine shaft . Mathematically

$$\text{Electric power} \quad (P) = WQH\eta \times 9.81 \times 10^{-3} \text{ KW}$$

$$W = \text{Sp. Weight of water in Kg/m}^3$$

$$Q = \text{Rate of flow of water m}^3/\text{Sec}$$

$$H = \text{Height or head in meter}$$

$$\eta = \text{Efficiency of power plant}$$

HYDROLOGICAL CYCLE:

The process by which moistures from the surface of water bodies covering the earth surface transferred to the land & back to the water bodies again called hydrological cycle.

HYDROLOGY:

The study of hydrological cycle is called hydrology i.e. Hydrology deals with occurrence & distribution of water over & under the earth surface.

Some definition

a. Precipitation

It may be defined as the total condensations of the moisture that reach the earth surface in any form i.e. ice, hail, sleet, dew & frost etc.

b. Evaporation

The process by which all the rainfall is returned to the atmosphere from the land & water surfaces called evaporation.

Evaporation includes evaporation from land & water surfaces. Evaporation by transmission & atmospheric evaporation

c. Runoff

It may be defined as the part of precipitation which is available as stream flow i.e.
 $\text{Runoff} = \text{Total precipitation} - \text{Total evaporation}$

HYDRO GRAPH:

It is graphical representation of discharge or flow with the time. Here flow is in ordinates in height number of $\text{m}^3/\text{sec} \times \text{km}^3$ or K.Watt. & time as abscissa in hour, day, week, month or year.

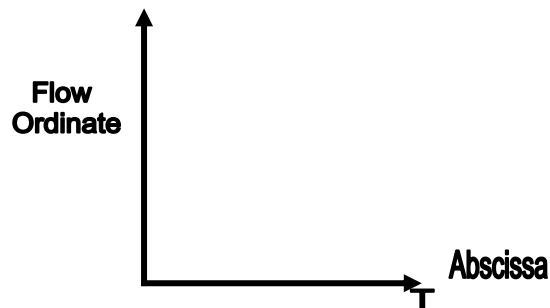

FLOW DURATION CURVE:

It is the graph between flows & length of time during which they are available.

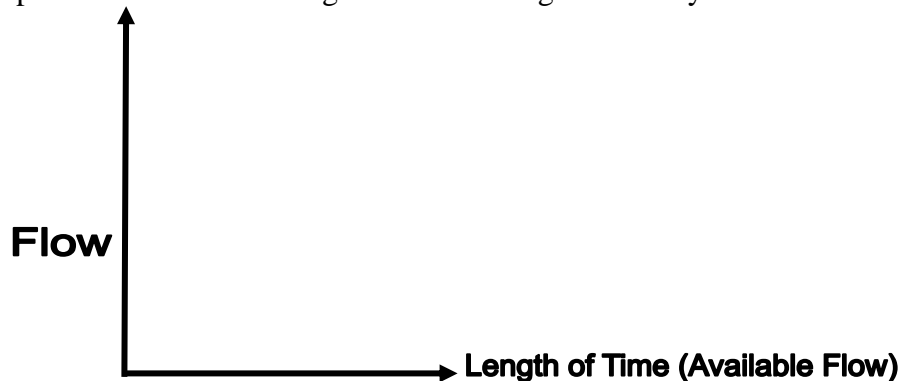

MASS CURVE:

The curve which indicates the total volume of run-off in M^3 of to a certain time.

STORAGE:

Generally water flows excess during one seasons & less during another. So it is made to provide water constantly.

PONDAGE:

The water storage if present at far away from power plant then a small pond is required near the power plant to provide hourly changes in power demand.

HYDRO ELECTRIC POWER STATION

The power station which convert the kinetic energy of water in electrical energy are called hydro electric power station.

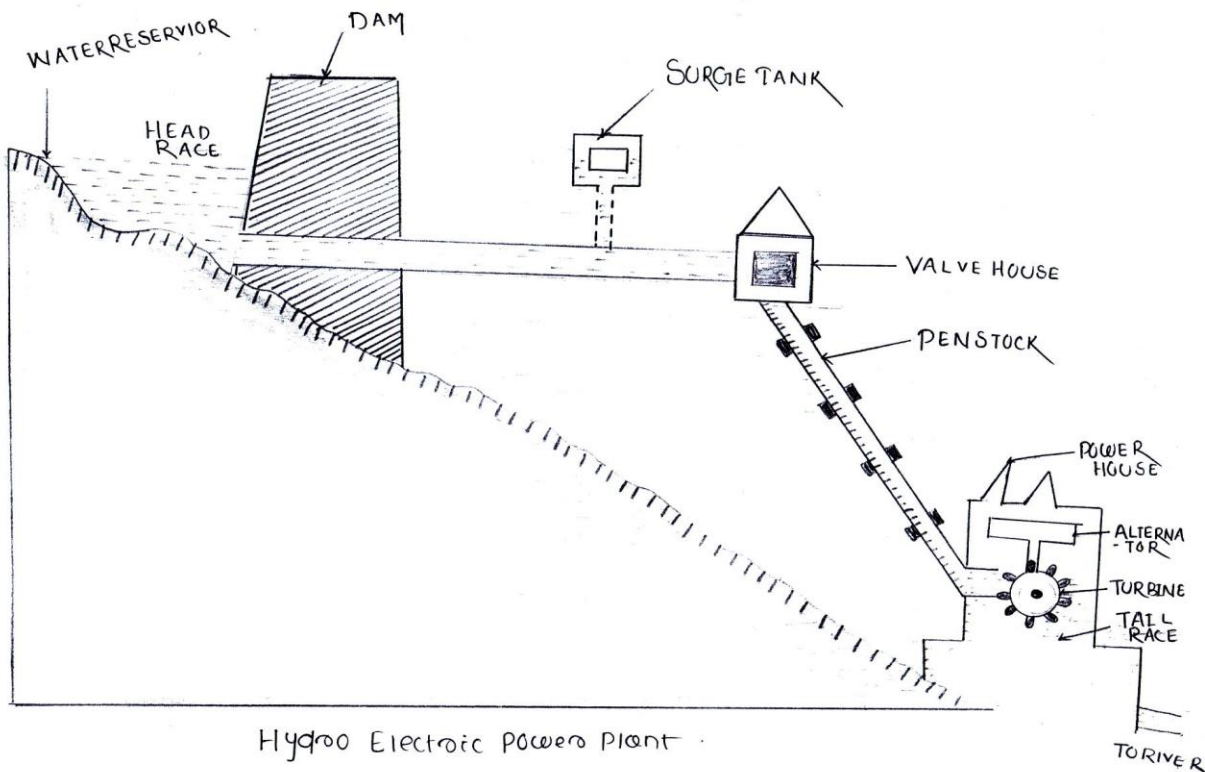

ELEMENTS OF HYDRO ELECTRIC POWER PLANT:

a. Storage reservoir

It stores water during excess flow periods (Rainy Seasons) & supplied the same during least flow of periods i.e. (dry seasons)

It can be either natural i.e. lake or artificial made by construction dam across the river.

b. **Dam** :- It is the most expensive & important part which is built up concrete or stone masonry earth or rock fill. It is not only raise the water surface by creating artificial head but provide pondage or storage.

c. **Fore bay** :- It serves as regulating reservoir storing water temporary during light load period & providing same during increased load period i.e. it is either a pond behind the diversion dam or an enlarge section of canal spread out to accommodate required with of intake.

d. **Spillway** :- These are constructed to discharge the over flow water to the downstream. When the reservoir is full. Generally it acts as safety valve during flood situation.

e. **Intake** :- Generally intake includes head works i.e. structure at the intake the conduits & tunnel or flumes which are res possible for diverting & preventing entry of debris & ice into the turbines. These structures includes booms, screams, rocks or sluices.

SURGE TANK:

Surge tank regulates & maintains required pressure in the penstock. Because during light load pressure in the penstock becomes more even if which can burst the penstock but surge tank reduces the pressure by raising water level inside it. Similarly during the low pressure additional water flows provided by it. So search tank stabilize the velocity & pressure in the penstock.

VALVE & GATES:

Generally these are fitted at Entrance to the turbine during in section & repairing these are shut off.

TAIL RACE :

The water from turbine is discharged to the tail race generally tail race may be same stream or another one but design & size of tail race should be search that water are free exist.

PRIME MOVERS / WATER TURBINES:

In hydro power plant water turbines are used as prime movers which convert kinetic Energy of water into mechanical energy which is further utilized to drive the alternators generating electric at energy.

SELECTION OF SIDE FOR HYDRO ELECTRIC POWER PLANT :

These are some factors which are taken in to consideration for the selection of site for hydro electric power plant i.e.

1. Availability of water :

Hydro electric power plant should be built where there adequate water available at goof head or huge quantity of water is flowing across a given point

WATER STORAGE:

For continuous supply of water. The water storage in suitable reservoir at height or building of dam across the river is essential so convient accommodation for the erection of a dam per Reservoir must be available.

WATER HEAD:

It has a considerable effect on the cost & economy of power generation i.e. an increasing effective head reduces the quantity of storage water & handle by pen stock screens & turbine resulting reduction in cost.

DISTANCE FROM LOAD CENTRE:

Generally these plant locate far away from load center so roots & distances affects on economical transmission.

ACCESSIBILITY OF SIZE:

It requires adequate transportation facilities for easy transportation required equipment & machine

AVAILABILITY OF LAND:

The land available must be cheap & rocky to with stand large building & machinery.

Merits :-

1. No fuel is required by such plant because water is the source of energy.
2. It is highly reliable & cheapest & operation & maintenance
3. No. Stand by loss & variable load demand can meet easily
4. Good longer life & robust.
5. Efficiency does not fall with age & it has neat & clean environment due to absence of smoke & ask.
6. In addition to generation of provides irrigation flood control on navigation.

Demerits :-

1. It covers large area.
2. Constructional cost is very high along with it requires long transmission line as it far away from load centre.
3. Its O/P is uncertain

STEAM POWER PLANT OR THERMAL POWER PLANT :

The power plant which generates electrical energy from the combustion of coal called steam power plant

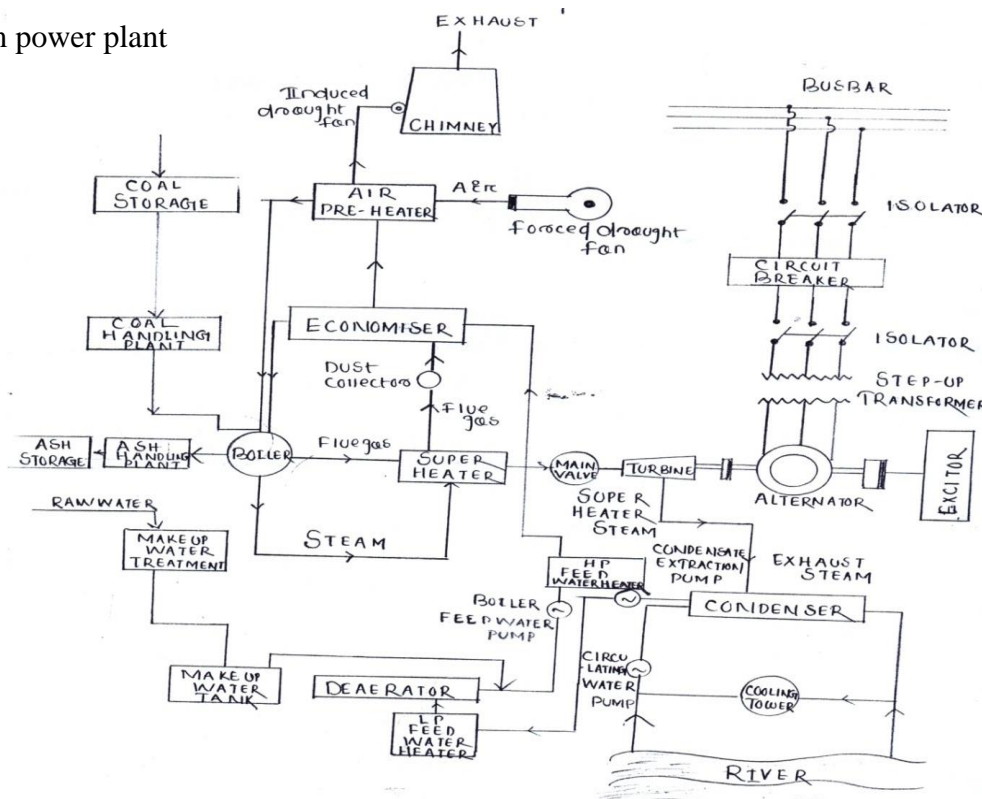

ELEMENTS OF THERMAL POWER PLANT :

1. STEAM GENERATING EQUIPMENT:

- a. **Boiler:-** It is a major part of thermal power plant which convert water into steam. It is of two types fire tube boilers & water tube boilers in fire tube boilers the tubes containing hot gasses of combustion surrounded with water while in water tubes water inside the tube while hot gasses outside.
- b. **Boiler furnace:-** Boiler furnace is a chamber in which fuel is burnt to liberate the heat energy it also provides support & enclosures for combustion equipment i.e. burner.
- c. **Super heater & re-heater :-** A superheater is a device which removes the last traces of moisture from saturated steam leaving a boiler tubes & also increase its temp. above the saturation temp.

Re-heater :-

It re-super heat the partly expanded steam from the turbine resulting dryness of steam up to last stage of turbine

- d. **Economizer & Airpre-heater :-**

Those are such devices which recover the heat from the flue gases on their way to chimney & raise the temp. of feed water. & air supplied for combustion.

2. CONDENSER:

Steam after expansion through prime movers goes through condenser which condenses the exhaust steam & also removes air & other unwanted gases from steam while passing through them.

It is up two types.

1. Jet or contact condenser
& surface condenser

3. **EVAPORATOR :-**

These are employed for feeding pure water to steam power plant by evaporating raw water.

4. FEED WATER HEATER :-

These heat the feed water by means of bled steam before supply to the boiler which dissolves improve efficiency.

5. PRIME MOVER:-

It converts the stored energy in steam into rotational mechanical energy. It is either reciprocating or turbines. Now raises only steam turbine are use as prime movers.

WORKING PRINCIPLE OF STEAM POWER PLANT :-

The working of thermal power plant can be summarized as be follows.

FUEL & ASH CKT :-

Generally heavy amount of fuel i.e. coal is stored in coal storage his again transfer to boiler furnace through coal handling plant. Where gates pulverization. After combustion the resulting ash get transfer to ash storage to ash handling plant.

AIR & FLUE GAS CKT :-

Here, atmospheric air is drawn by forced draught fan or induced draught fan through air preheated in which air is heated by heat of flue gases passing to chimney & finally air is passed to furnace. Similarly, flue gas after passing through boiler & super heater drawn by induced draught fan via dost collector (Precipitator). Economizer & Airpre heater) Finally Exhausted to the atmosphere to the chimney.

FEEDWATER & STEAM CKT:-

Generally steam coming from boiler is wet & having high pressure, which again dried & further super heated by super heater & supply to steam turbine through main valve where it gives heat energy & passes through condenser.

Now, the condensate steam is extracted from the condenser to the low pressure feed water by condensate extraction pump.

Where it gets heated up at low pressure & pumped to high pressure water heater through deaerator & finally to boiler through economizer where it gets heat again by heat of flue gas passing it on the way of chimney.

Here the function of deaerator reduces dissolved oxygen in the condensate steam.

Generally a small part of steam & water is passing through different components are lost. So water is added to feed water as make up water by makeup water treatment.

COOLING WATER CKT :-

The cooling water is supplied from the natural source of supply i.e. river, lake canal etc through screens to remove the matter that might choke condenser tube. The circulation of cooling water maintains low pressure in condenser.

SELECTION OF SITE FOR THERMAL POWER PLANT :-

There are different factors which govern the site selection.

1. Near to the load center :-

It locates near the load center resulting low transmission cost & loss.

2. Supply of water :-

Large quantity of water is required

1. To raise steam in boilers.
2. For cooling
3. For carrying disposal of Ash.
4. For drinking

3. Availability of coal :-

It requires huge amount of coal so plants are located near the coal mines to avoid the transport of coal & ash.

4. Load requirement :-

Land is required not only for setting of plant but also other purposes for staff colony, coal storage ash disposal etc.

TRANSPORTATION FACILITIES:-

These facilities must be available for transportation of heavy equipment & fuels i.e. near railway station.

Merits :-

1. The fuel (i.e. coal) used is quite cheap.
2. Cheaper in initial cost in comparison to the other plant.
3. Less space is required in comparison to hydropower plant.
4. Such plant can be installed at any place where as hydro electric plants can only be developed at source of water.
5. A portion of steam raised can be used as process steam in various industries like paper mill, sugar mill, chemical etc.

Demerits :-

1. High maintenance & operating cost.
2. Pollution of atmosphere due to fumes & residues
3. Consumption of huge amount of water.
4. Handling of coal & disposal of ash is quite difficult
5. Troubles from smoke & heat from the plant.

NUCLEAR POWER PLANT:-

The power plant which generates electricity by utilizing the vast energy released from nuclear fission reaction is known as nuclear power.

NUCLEAR FISSION :-

The nuclear reaction in which a heavy nucleus is split into small nuclei with liberation of vast energy by bombardment of neutron is known as Nuclear Fission Reaction.

Eg- chemical reaction

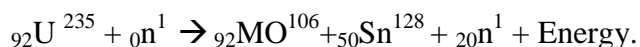
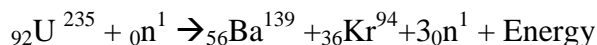

Note :-

1 kg of natural uranium give energy equivalent to combustion of 10.500 kg of coal i.e.

$$0.7/100 \times 3 \times 10^6 \times 0.5 \text{ Joule}$$

NUCLEAR CHAIN REACTION :-

It may be defined as a fission reaction where the neutrons from a previous step continuity propagate & repeat the reaction i.e.

Components of the nuclear power plant :-

a. Nuclear Reactor :-

It is the main part of nuclear power plant which is very similar to boiler of thermal power plant it has following component.

1. Reactor core :-

It contains a number of fuel rods made of U^{235} , U^{234} , U^{233} etc. as uranium gets oxidised rapidly so fuel rods clad with aluminum stainless steel or zirconium.

2. Moderator :

The moderator moderate or reduces the neutrons speed to a value that increase the probability of fission reaction. The elements which are used as moderator in nuclear reactor are hydrogen deuterium He , Li, oxygen ,carbon heavy water etc.

3. Control Rods:

The control rods which are made of Boron-10 cadmium or Hafnium are inserted in to nuclear reactor from the top of reactor vessels. The control rods control rate of the nuclear fission reaction by absorbing neutrons. It can be inserted or taken out as according to requirement i.e. if we need increased rate of reaction we have to taken out & vice verse.

4. Coolant :-

It is the medium through which heat generated in the reactor is transferred to the heat exchanger & it also keeps the reactor at desired temp.

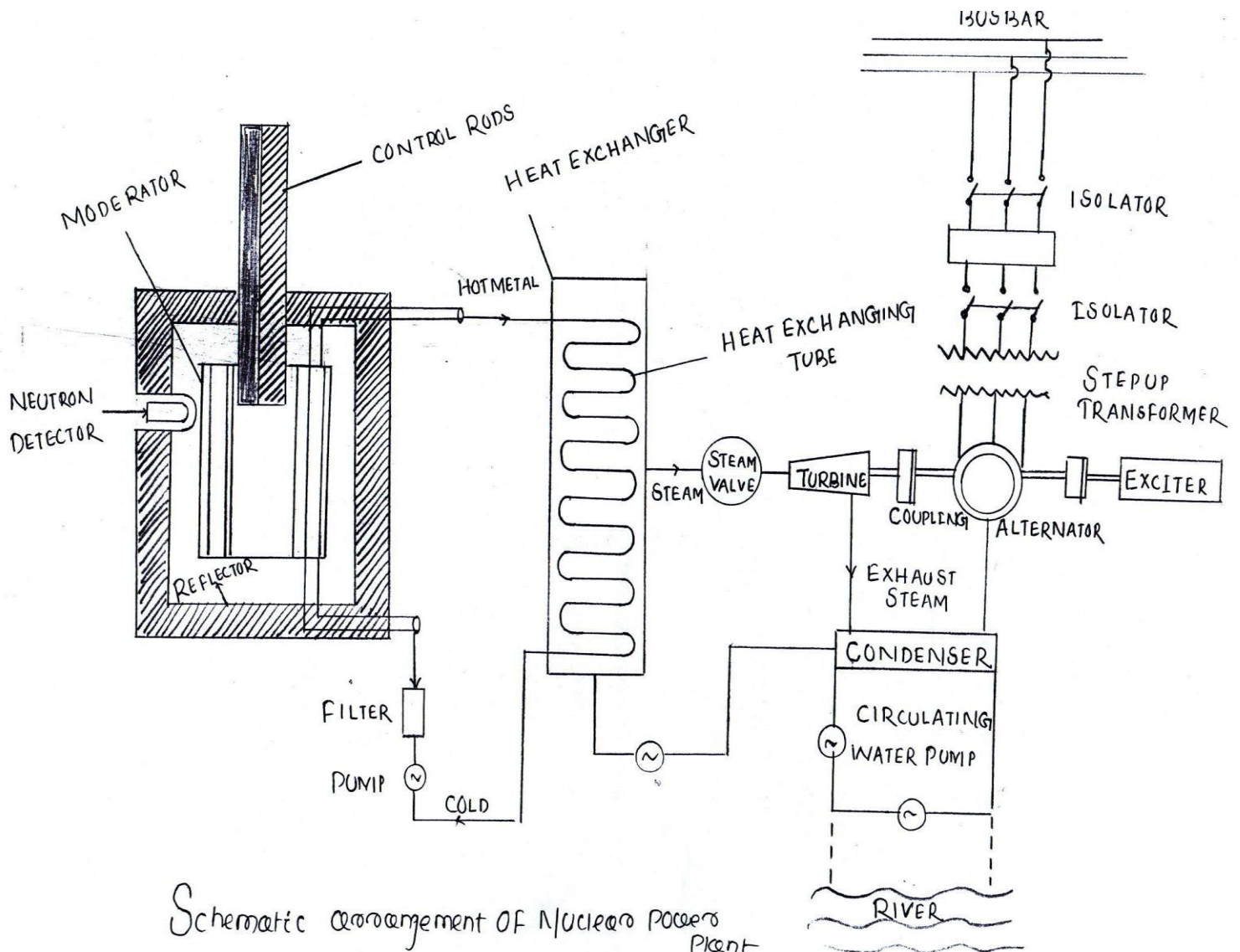

Schematic arrangement of Nuclear power plant

- a. The material like air He, H & CO₂ amongst the gases light or heavy water amongst the liquid or molten sodium or lithium amongst the metal used as coolant.
- b. **Heat Exchanger** :-In heat Exchanger the gas is heated or steam is generated by utilizing heat from nuclear reactor, here heat is connected by heat exchanger tube by circulation.
- c. **Steam turbine** :- The Steam produce in heat exchanger is transferred to steam turbines through steam valve where heat energy is converted in to mechanical energy.
- d. **Condenser** : The exhausted steam from steam turbine is condensed by condenser & again feed to heat exchanger by feed water pump.
- e. **Alternator** :- It is coupled to steam turbine & it generate electricity by converting mechanical energy to convert in to electrical energy.

SELECTION OF SITE FOR NUCLEAR POWER PLANT :

The factor to be considered while selecting a site for nuclear power plant for economical deficient generation.

Availability of water supply :-

1. It requires more water i.e. two times of thermal power plant of same rating. So it located near the river, sea side or lake.
2. **Distance from populated area:-**
Generally these are located for away from populated area due to danger of radio activity.
3. **Nearness to load center :-**
Those plants can be located near the load center because of absence of transportation.
4. **Availability of space for disposal of water :-**
Their should have adequate space & arrangement for the disposal of radio activity waste.
5. **Types of land :**
The land should be strong enough to support the heavy reactor i.e. 10,000 tones weight with imposed boarding pressure around 50 tones /m²

Merits :-

1. It requires very small fuel.
2. It requires less area as compared to in other plant

3. In addition to generating power it powder variable Fissel material.
4. It can be located at load center resulting reduction in primary distribution cost.
5. It has most economical & flexible O/P.
6. The operating cost quite low after installation.

Disadvantages:

1. The initial cost is very high as compared to any other plant.
2. It required greater technical known – how forits irrection & commissioning of the plant.
3. It bi-product is also radio activity causing dangerous pollution.
4. The fuel is used is very expensive & difficult to recover.
5. High maintenance charges
6. Heavy amount of water is needed.

CHAPTER-2

TRANSMISSION OF ELECTRIC POWER

Draw layout of transmission and distribution scheme.

Generally generating stations are situated far away from load centre hence a power supply network connects the generating stations to load centre. As follows

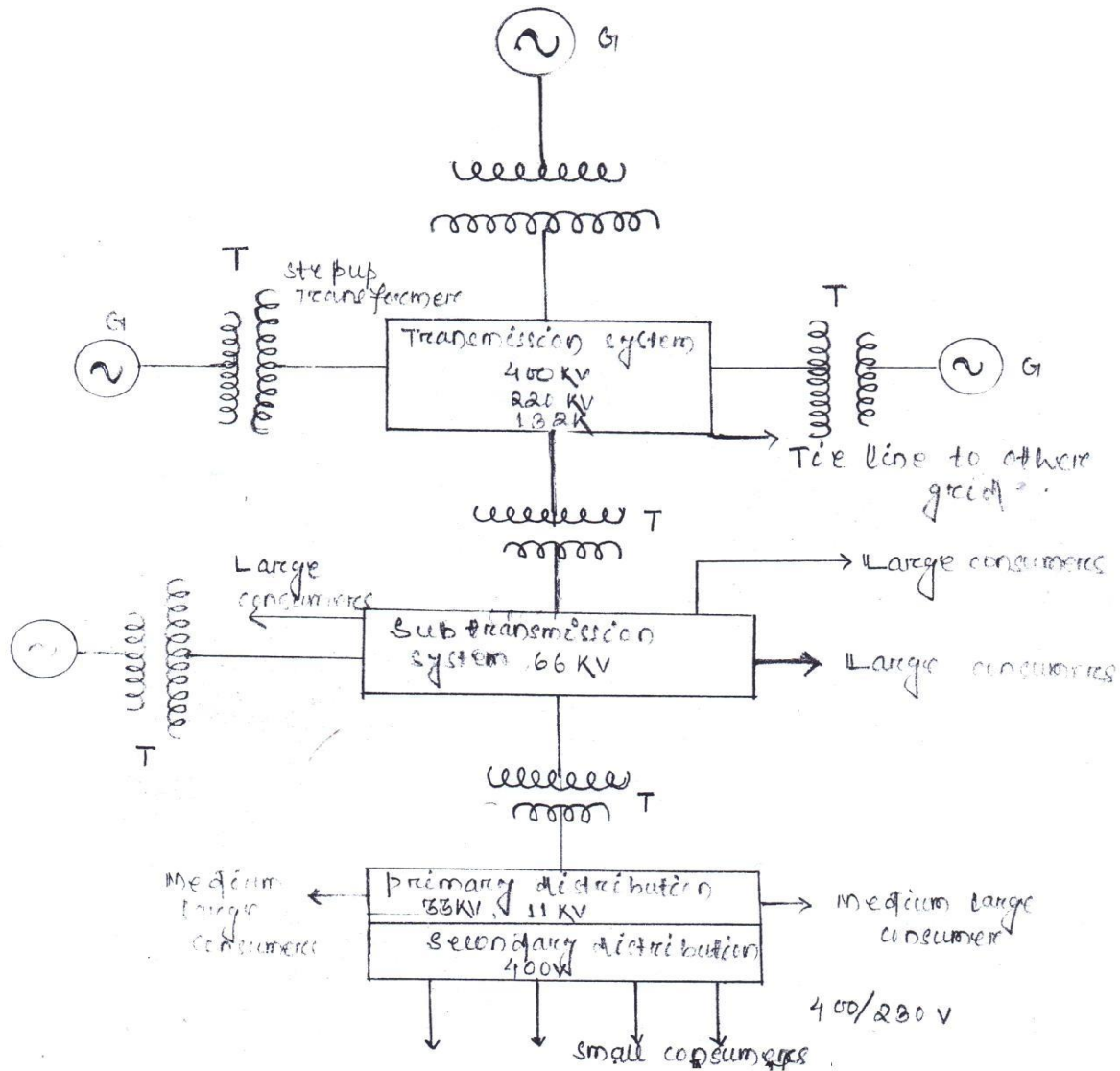

Here power system generally composed of transmission system and distribution system, which again divided into primary and secondary (or sub). Generally voltage is generated in 33kv (in advanced countries) 11 kv (in India) which if transmitted results in heavy current and power loss.

Which if transmitted results heavy current and power losses. So there are stepped up to a higher value i.e. 66kv 132kv 220/230kv and 400kv step up transformer present near generating station and transfer to primary transmission system. Where it step down and transmitted to secondary transmission. Again voltage is step down to 33kv or 11kv and transmitted to primary distribution system from where medium large consumers connected and finally voltage step down to 400v at secondary distribution system and fed to small consumers.

1.2 Voltage regulation :

It is defined as the difference of supply end voltage and relieving end voltage to the receiving end voltage in other word.

The voltage drop i.e. difference of secondary end voltage and receiving end voltage expressed as a percentage of receiving end voltage called regulation.

Mathematically

$$\% \text{ voltage regulation} = \frac{V_S - V_R}{V_R} \times 100$$

V_S = Supply end voltage

V_R = Receiving end voltage

EFFICIENCY :

It is defined as the ratio of power delivered at the receiving end to the power sent from the sending end.

Mathematically $\eta = \frac{P_R}{P_S} \times 100$

$$= \frac{P_R}{P_R + P_L} \times 100$$

Where $P_R = V_R \cdot I_R$ $P_{Rr} =$ Receiving end power

$P_S = V_S \cdot I_S$ $P_{Ss} =$ Sending end power

An overhead 3-d Transmission line delivers 5000kw at 22kv at 0.8 p.f lagging with resistance and reactance of 4-2 and 6-2 respectively. Calculate (1) percentage regulation (2) efficiency.

Solution:

$$V_R = 22\text{KV}$$

$$V_{PH} = 22/\sqrt{3} = 12700\text{V}$$

$$Z_{PH} = 4 + j6$$

Here sending voltage / phase $V_S = V_{ph} + I z_{ph}$

$$\text{Here } I = 500 \times 10^3 / \sqrt{3} \times 22 \times 10^3 \times 0.8 = 164\text{A}$$

$$I = 164 - 36.86$$

$$\text{So } V_S = 12700 + 164 - 3686 \times 7.2 = 56.31$$

$$= 12700 + 1180.8 = 19.45$$

$$= 12700 + 1113.41 + j 393.6$$

$$= 13813.4 + j 393.6$$

$$= 13819 \angle 1.6$$

$$\text{Voltage regulation} = (V_S - V_R) / V_R \times 100$$

$$= (13819 - 12700) / 12700 \times 100 = 8.825\%$$

$$\text{Efficiency} = \frac{P_R}{P_R + 3I^2R} = \frac{5000 \times 100}{5000 + (3 \times 164^2 \times 4)} = 93.94\%$$

P_L = Line losses

1.3 Kelvin's Law :

The law states that the most economical area of conductor is that for which the total annual cost of transmission is minimum

Generally annual cost split into two part

- a. Annual charge on capital out lay i.e. $P_1 + P_2$
- b. Annual cost of energy wasted i.e. P_3/a

Where P_1 , P_2 and P_3 are constants and 'A' area of X- section of the conductor.

So, total annual cost (C) = $P_1 + P_2 a + P_3/a$

For minimum

$$DC/DA = 0 \text{ i.e. } D/DA (P_2 a + P_1 + P_3/A) = 0$$

$$= P_2 - P_3/a^2 = 0$$

$$P_2 \cdot a = P_3/a$$

i.e. variable part of annual charge = Annual cost of energy wasted.

In other word it can be stated that the most economical area of conductor is that for which the variable part of annual charge is equal to the cost of energy losses per year.

Graphically :

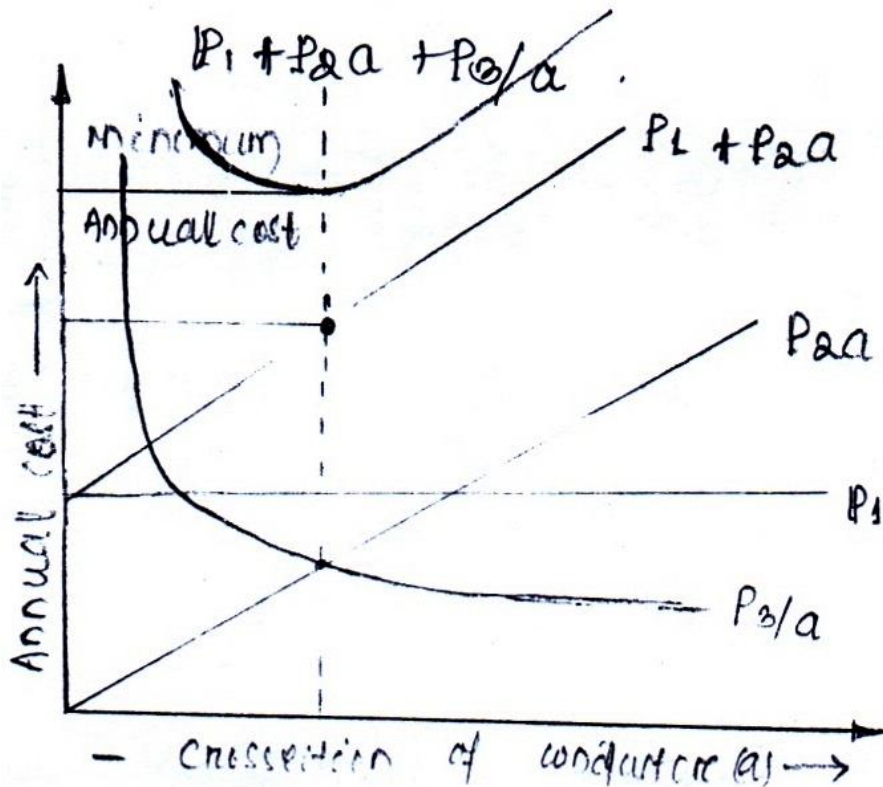

Limitation :

- (i) Difficult to estimate the energy loss in the line without load curve, which is not available at the time of estimation.

- (ii) Annual charge on capital out day i.e. P_1+P_2 a not true Eg.- neither the cost of cable dielectric and heath in underground cables the cost of laying vary in this manner.
- (iii) Current density, mechanical strength, corona loss are not considered.
- (iv) By this low conductor size may be too small to carry the necessary current safely.
- (v) Interest and depreciation not determined accurately.

CORONA :

The phenomenon of violet glow, hissing noise and production of zone gas in an overhead transmission line is known as corona.

The phenomenon of corona is accompanied by a hissing sound and production of ozone gas due to corona also increases.

In case of polished and smooth, the corona glow will be uniform throughout the length of the conductor, otherwise the rough points will appear brighter.

In case of D.C. Supply the TVC wire has uniformly glow. While the -ve conductor has spotty glow.

Formation of corona :

Under normal condition, the air around the conductors contain some ionized particles like free electrons and +ve ions and neutral molecules. Due to ultra-violet ray and radioactivity applied, the potential gradient is setup in the air. When the potential gradient at the conductor surface reaches about 30 kv per cm the velocity acquired by the free electrons is sufficient to strike a neutral molecule with enough force to dislodge one or more electrons from it. This produce another ion and one or more free electrons. Those electrons again collides with the other neutral molecules and produces other ions. This process of ionization is cumulative. As a result corona is formed.

Factors affecting corona :

1. **Atmosphere :** In stormy weather corona occurs more than in normal weather due to more ions than the normal weather.
2. **Conductor size :**

The rough and irregular surface will produce more corona.

3. Spacing between conductors:

If the spacing between the conductor is made very large as compare to their diameter, there may not be any corona effect

4. Line voltage : In low voltage no corona is formed

Critical disruptive voltage :

It is the minimum phase to neutral voltage at which corona occurs.

Visual critical voltage :

It is the minimum phase neutral voltage at which corona glow appears all along the line conductors.

Power loss due to corona:

Due to corona electric energy is lost. Which is dissipated in the form of light, heat, sound and chemical action. Power loss due to corona is

$$P = 242.2 (F + 25/6) \sqrt{R/D} (V - V_X)^2 \times 10^{-5} \text{ KW/KM/PH}$$

VC = disruptive voltage /Phase.

a. Advantages :

- i. Reduces electro static stress between the conductors
- ii. Reduces transient due to surges.

b. Disadvantages :

- i. It reduces transmission efficiency
- ii. Corrosion of conductor occurs due to ozone
- iii. Inductive interference due to non- sinusoidal voltage

c. Methods reducing corona :

- 1. Large dia conductor
- 2. Hollow conductors
- 3. Bundled conductor

CHAPTER-3

LINE SUPPORTS

The line supports should have the following properties.

1. High mechanical strength to withstand the weight of conductor and wind loads.
2. Light in weight
3. Long life
4. Cheap in cost
5. Easy accessibility of conductors maintenance.

The line supports used for transmission and distribution of electric power are made in either wood, steel, R.C.C. or lattice steel.

WOODEN POLE : Wooden poles are made of woods. this type of poles are used for shorter spans up to 50 meters. These are mainly used in rural areas.

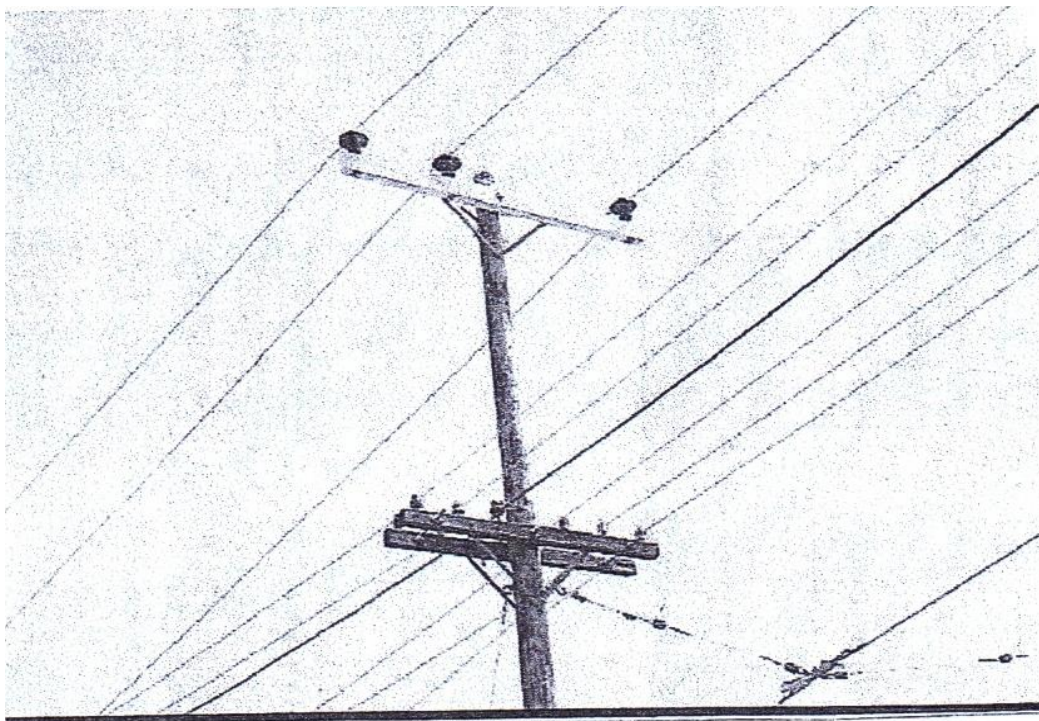

2. SHACKLE INSULATORS:

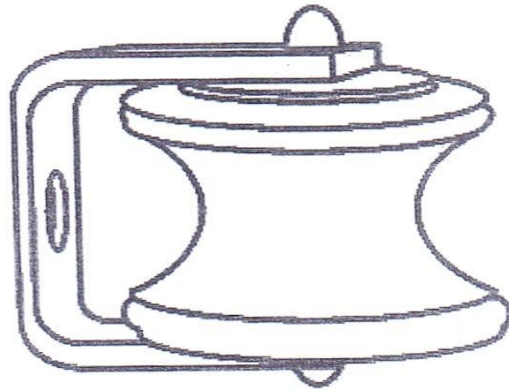

Shackle or Spool Insulator

For low voltage line less than 11KV shackle insulators are used as strain insulators. this is also known as spool insulators. it is used in low voltage distribution lines. Such insulators can be used either in a horizontal position or in a vertical position. They can be directly fixed to the pole with a bolt or cross arm. The conductor in the groove is fixed with soft binding wire.

Coconut oil are impregnated in the ground level of the wooden pole for better foundation. these wooden poles has smaller life 20 to 25 years. Also it has less mechanical strength. it can't be used for voltage higher than 20kv.

Steel poles :

The steel poles are used generally for the distribution purpose in the city areas it has high mechanical strength with longer life poles. The outer surface of the pole is painted for longer life.

These poles are three types.

1. Rail poles
2. Tabular poles
3. Rolled steel joints

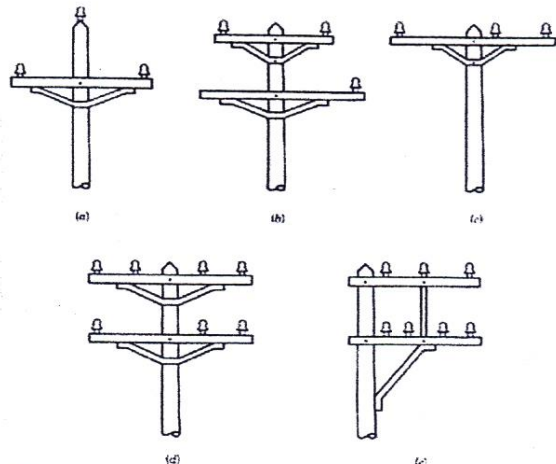

R.C.C. POLES :

These poles are very popular in recent days. They provide longer span than steel and wood poles. They have greater mechanical strength with longer life.

These type of pole require low maintenance it has good insulating properties.

These poles are heavy weights. So the cost of transportation is high.

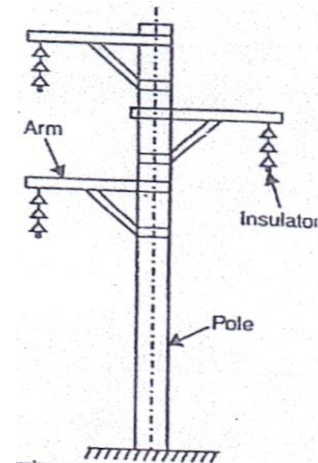

STEEL TOWERS:-

For long distance transmission at higher voltage steel towers are used. These steel towers have longer life, great mechanical strength. It is suitable for severe climate conditions. These type of steel towers are used for longer spans. Tower footings are grounded by driving rods into the earth. This minimizes the lightning troubles as each tower acts as a lightning conductor. It can also be used as a double circuit tower which allows continuity of supply in case of one circuit breakdown.

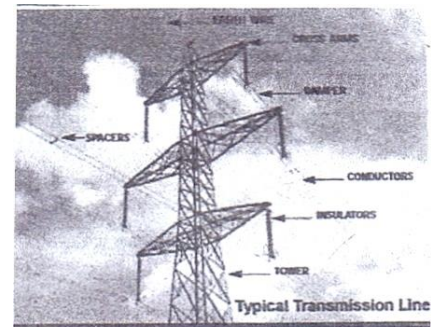

TYPES OF INSULATOR

INSULATORS :-

An electrical insulator is a material whose internal electric charges do not flow freely.

In overhead transmission or distribution lines insulators are used to insulate the current flowing in the conductor to earth through the poles or towers.

The most commonly used materials for insulators of overhead lines are porcelain.

Types of insulator in overhead lines :-

There are mainly three types of insulators used on overhead lines for high voltage.

1. **Pen type insulator**
2. **Suspension type insulator**
3. **Strain type insulator**

There are two other type insulators are used for low voltage over head lines. These are.

1. **Stay type insulators**
2. **Shackle type insulators**

1. **Pen type insulators :** This type of insulator is popularly used in power network up to 33kv system. The pen type insulator is secured to the cross arm on the pole. The live conductor attached to the top of the pen insulator the shortest distance between conductor and earth, surrounding the insulator body along which electrical discharge may take place through air is known as flash over distance.

When the insulator is wet, its outer surface becomes almost conducting. Hence the flash over distance of insulator is decreased. So the design of the electrical insulator (pin type) is umbrella type on the upper part, so that it can protect the rest lower part of the insulator from rain.

2. Suspension type insulator :-

This type of insulator is used beyond the voltage 33kv. The pin type insulator is not economical for beyond the voltage 33kv. In this type of insulator number of insulators are

connected in series to form a string and the line conductor is carried by the bottom most insulator. Each insulator of a suspension string is called disc insulator because of their disc shape. Each disc is design for 11kv the number of disc in series

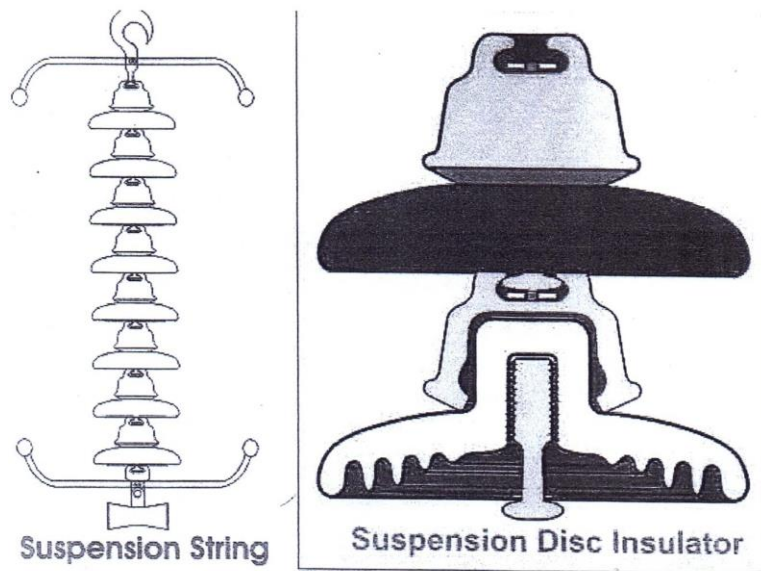

would depend upon the working voltage. If any of the disc is damaged, then that disc can be replaced. There is no need to change the whole string. If the line voltage will increase, then that can be insulated by adding more disc in string. This type of insulators are mainly used with steel towers. As the conductor runs below the earthed cross arm of the tower, therefore this arrangement provides partial protection from lightning. The spacing between the conductor is more when suspension type insulator is used in overhead lines.

3. Strain insulator :

When there is a dead end of the line or there is a sharp curve the line is subjected to greater tension.

In order to relieve the line of excessive tension, strain insulators are used. A strain insulator consists of an assembly of suspension insulators. It has considerable mechanical strength.

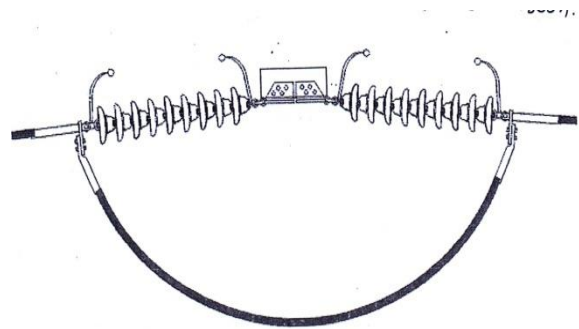

LOW VOLTAGE APPLICATION INSULATORS :

1. Stay insulator :

For low voltage range lines, the stays are to be insulated from ground at a height.

Stay Insulator

This insulator used in the stay wire is called as the stay insulator.

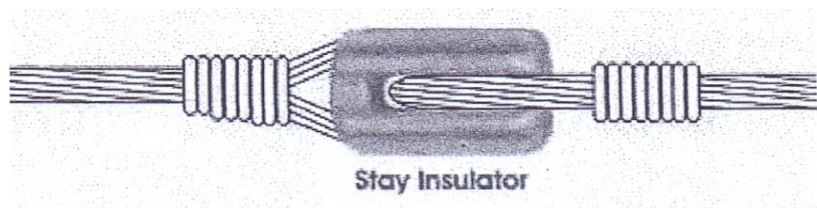

Calculation of sag :

The sag should be so adjusted that tension in the conductor is within safe limits.

The tension is governed by conductor weight, effects of wind, ice loading and temperature variations.

1. When supports are at equal levels :

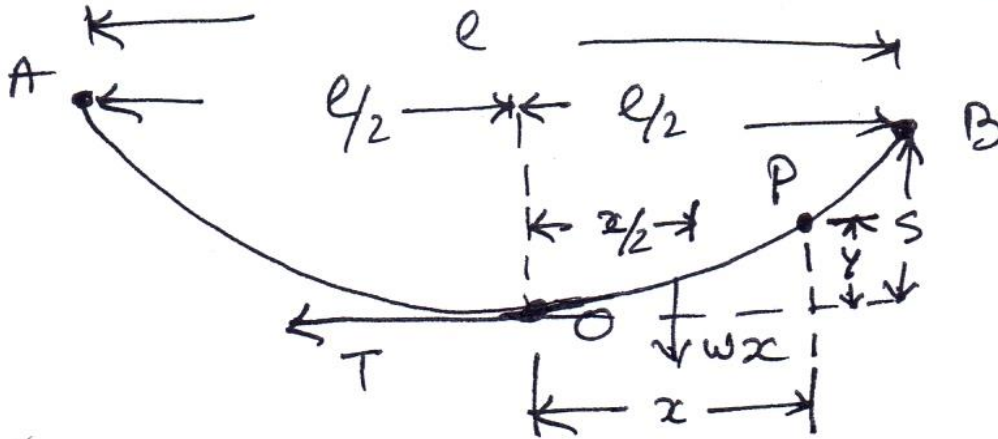

The above figure shows a conductor is placed between two equilevel supports A and B. The point O is the lowest point.

If L = Length of span

W = Weight per unit length of conductor

T = Tension in the conductor

Consider point 'P' on the conductor let the distance between point 'O' and p in horizontal projection is X .

There are two forces acting on the conductor portion 'OP'

1. The weight Wx of the conductor acting at a distance $X/2$ from 'O'
2. Tension T acting at 'O'

If we equate the two forces on the conductor at Point 'O'.

We get $Ty = Wx (x/2)$

$$Y = WX^2/2T$$

If the sag is represented by the value of 'Y'

At support 'A' $X = L/2$ and $Y = S$

Then sag $S = W (L/2)^2 / 2T$

$$S = WL^2 / 8T$$

CALCULATION OF SAG

When supports are at unequal levels :-

Unequal level supports are normally found in hilly areas. The above figure shows a conductor suspended between two supports A and B at different levels. Consider the lowest point is 'O'

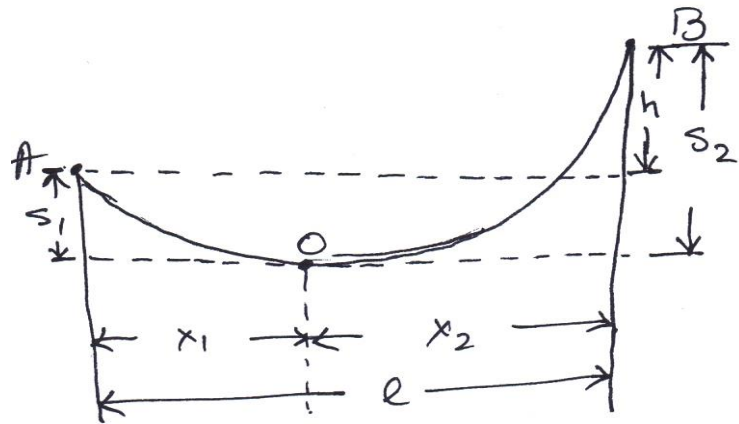

Let $L =$ Span Length

$H =$ Difference in levels between two supports

$X_1 =$ Distance of support at lower level from 'O'

$X_2 =$ Distance of support at higher level from 'O'

$T =$ Tension in the conductor.

If "W" is the weight per unit length of the conductor, then

$$\text{Say } S_1 = WX_1^2 / 2T \quad (Y = WX^2 / 2T)$$

$$\text{Sag } S_2 = WX_2^2 / 2T$$

From the figure $X_1 + X_2 = L$

By subtracting S_2 from S_1

$$S_2 - S_1 = W / 2T (X_2^2 - X_1^2)$$

$$S_2 - S_1 = W / 2T (X_2 + X_1) X (X_2 - X_1)$$

We know $X_2 + X_1 = L$

Then $S_2 - S_1 = WL/2T (X_2 - X_1)$

From the figure $S_2 - S_1 = H$

Equation-3 becomes

$S_2 - S_1 = H = WL/2T (X_2 - X_1)$

$X_1 - X_2 = 2TH/WL$

By solving eqn.-3 & 5, we will get

$X_1 = L/2 - TH/WL$ and $X_2 = L/2 + TH/WL$

Putting the values of X_1 and X_2 in Eqn. 1 & 2

We can calculate sag S_1 and S_2

THE EFFECT OF WIND AND ICE LOADING

ON THE CALCULATION OF SAG:

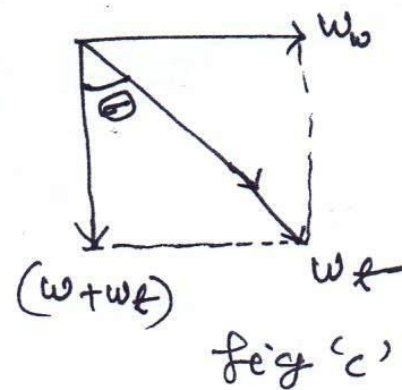
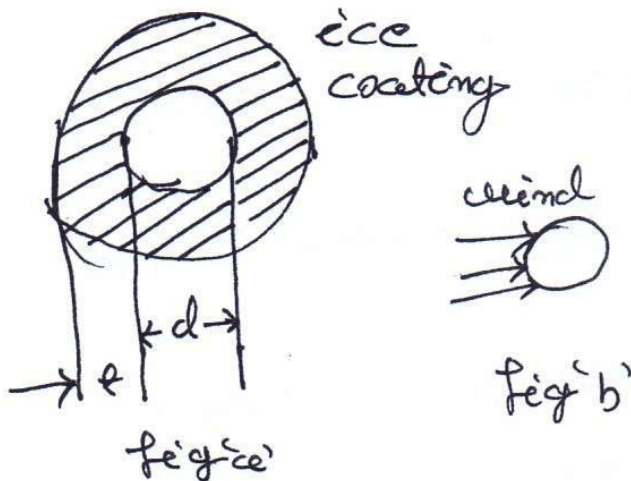

In some cases the conductor may have ice coating and simultaneously subjected to wind pressure – At this time the weight of the ice acts vertically down word as the same direction as the weight of conductor the force due to the wind is assumed to act horizontally as shown in fig. 'b'

The total force on the conductor due to wind and ice coating is the vector sum of horizontal and vertical forces as shown in fig 'C'

If W = Weight of the conductor for unit length

= Conductor material density \times

Volume per unit length.

W_i = Weight of ice per unit length

= density of ice \times volume of ice per unit length.

Density of ice \times $(d+t)$

W_w = wind force per unit length

= wind pressure per unit area \times projected area per unit length.

= wind pressure \times $[(1+2t) \times 1]$

Then $W_t = (w+w_i)^2 + (W_w)^2$

If the conductor sets itself in a plane at an angle θ to the vertical then

$\tan \theta = W_w / (W + W_i)$

Then the sag of the conductor is given

By $S = W_t L^2 / 2T$

The vertical sag = $S \cos \theta$

CHAPTER-4

Performance of Short & Medium Lines

Performance of Short & Medium Lines

Generally transmission Lines are classified according to their Lengths at the power Frequency $F=50\text{Hz}$ as follows.

Short transmission Lines :

Transmission Lines of Length up to 80Km are classified as short lines. Effect of capacitance is ignored in these lines.

Medium transmission Lines :

Transmission Lines of Length between 80Km to 160km are classified as Medium transmission lines. Here effect of capacitance is not ignored but capacitance is assumed to be lumped in the Middle or at the ends of transmission lines. Accordingly transmission lines are analysed using Nominal-T & Nominal π method.

Long transmission Lines :

Parameters in this type line can not be assumed lumped & rigorous calculations are required to analyse the line. Here length of Line $> 160\text{Km}$.

Short transmission Lines :

Here shunt conductance & shunt capacitance are neglected & series resistance & inductive reactance to be considered. It has following Ckt diagram.

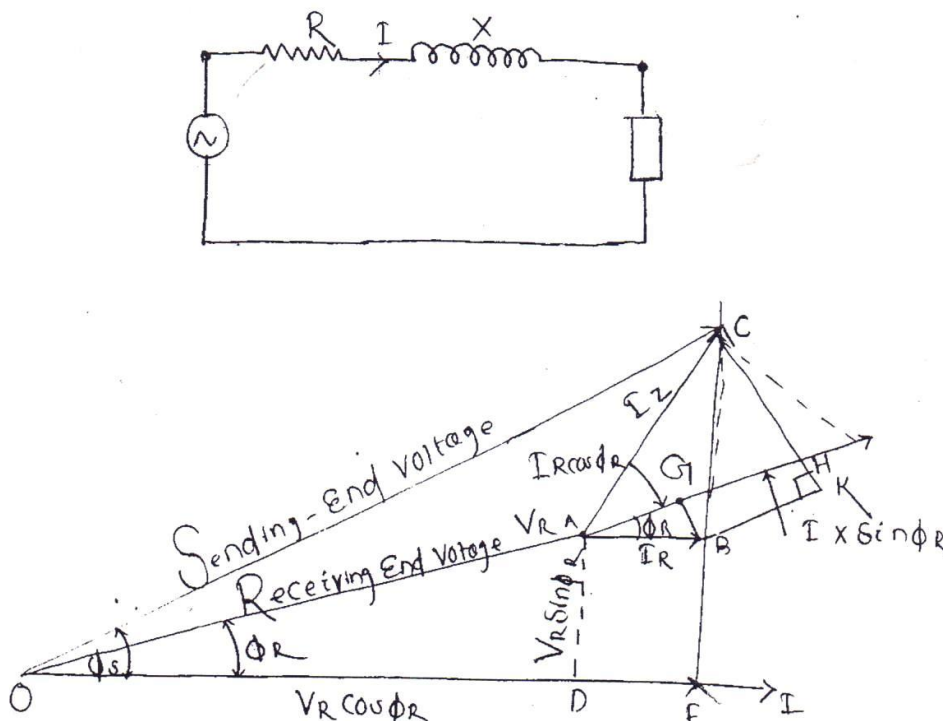

Here R = Resistance of both the conductions (i.e. go & return)

x = Inductive reactance of both conductors (i.e. go & return)

V_R = receiving eng voltage

V_s = Sending end voltage

$\cos(\phi)_R$ = receiving end power factor.

$\cos(\phi)_s$ = Sending end power factor.

From phaser diagram we have

$$OC = \sqrt{(OD + DF)^2 + (FB + BC)^2}$$

$$\Rightarrow V_s \sqrt{(V_R \cos \phi_R + I R)^2 + (V_R \sin \phi_R + I X)^2}$$

$$\text{Now \% voltage regulation} = \frac{V_s - V_R}{V_R} \times 100$$

Here, also we have

$$OC = OH = OA + AG + GH$$

$$V_s = V_R + I R \cos \phi_R + I X \sin \phi_R$$

$$\text{So } V_s - V_R = I R \cos \phi_R + I X \sin \phi_R$$

$$\Rightarrow \frac{V_s - V_R}{V_R} = \frac{I R}{V_R} \cos \phi_R + \frac{I X \sin \phi_R}{V_R}$$

$$\Rightarrow \text{voltage regulation (P.u.)} = E_r \cos \phi_R + E_x \sin \phi_R$$

Where E_r = P.u. resistive voltage drop

E_x = P.u. reactive / inductive voltage drop.

$$\text{Efficiency of transmission line } (\eta_t) = \frac{\text{power delivered to load}}{\text{Power Supplied Form Supply end}} \times 100$$

$$\% \eta_t = \frac{V_R I \cos \phi_R}{V_R I \cos \phi_R - I^2 R}$$

Note

(i) For leading power Factor.

$$\% \text{ Voltage regulation} = \frac{I R \cos \phi_R - I X \sin \phi_R}{V_R} \times 100$$

(ii) Total capacitance $C_T = C \times l$ C_T is Small because l small

$$X_{CT} = \frac{1}{2\pi FC_T} X_{CT} \text{ is So larjge.}$$

Hence charging current $I_c = \frac{V}{X_{CT}}$ is nearly Zero.

Hence Effect of capacitance Neglected.

Numerical : A 1ϕ line transmitting 1100kw power to a Load at 11kv & at 0.8 P.F lagging. It has total resistance of 2Ω & a loop reactance of 3Ω . Evaluate.

- (i) Voltage at Sending End.
- (ii) Percentage regulation
- (iii) Transmission Efficiency.

Solution- Load current $I = \frac{P \times 1000}{V_R \cos \phi_R} = \frac{1100 \times 1000}{11000 \times 0.8} = 125A$

(i) voltage at Sending Eng $V_s = \sqrt{(V_R \cos \phi_R + I R)^2 + (V_R \sin \phi_R + I X)^2}$

$$= \sqrt{(11000 \times 0.8 + 125 \times 2)^2 + (11000 \times 0.6 + 125 \times 3)^2}$$

$$= \sqrt{(9050)^2 + (6975)^2} = 11426V$$

(ii) Percentage regulation $= \frac{V_s - V_R}{V_R} \times 100 = \frac{11426 - 11,000}{11,000} \times 100$

$$= 3.873\%$$

Line Losses $= I^2 R = (125)^2 \times R = 31250 \text{ or } 31.25Kw$

(iii) Transmission Efficiency $(\eta_t) = \frac{\text{Power delivered}}{\text{Power delivered} + \text{line losses}} \times 100$

$$= \frac{1100 \times 100}{11,00 + 31.25} = 47.24\%$$

Numerical :

An over head 3ϕ transmission line delivers 5Mw at 22Kv at 0.8 lagging P.f. The resistance & reactance of each conductor is 4Ω & 6Ω respectively Evaluate..

- (i) Sending End Voltage
- (ii) Percentage regulation
- (iii) Total line losses

(iv) Transmission Efficiency.

Solution : Phase voltage at receiving End = $\frac{22 \times 1000}{\sqrt{3}} = 12.702V$

Load delivered $P = 5M\omega - 5 \times 10^6 \omega$

Load P.F. $\cos \phi_R = 0.8$ lagging

Line current $I = \frac{\text{Load delivered in watts}}{3 \times V_R \cos \phi}$

$$= \frac{5 \times 10^6}{3 \times 12.702 \times 0.8} = 164A$$

Sending End voltage per phase $V_S = V_R + I_R \cos \phi_R + I \times \sin \phi_R$

$$= 12702 + (164 \times 4 \times 0.8) + (164 \times 6 \times 0.6)$$

$$= 13.8172V$$

(i) Line Sending- End voltage $V_{SL} = \sqrt{3}V_S = \sqrt{3} \times 13817.2$

$$= 23,932V \text{ or } 23.932KV$$

(ii) Percentage regulation = $\frac{V_{SL} - V_{RL}}{V_{RL}} \times 100$

$$= \frac{23.932 - 22}{22} \times 100 = 8.782\%$$

(iii) Total line losses = $\frac{3I^2R}{1000} = \frac{3 \times (164)^2 \times 4}{1000} kW$

$$= 322.752kW$$

(iv) Transmission Efficiency (η_t) = $\frac{\text{out put power}}{\text{Out put power} + \text{Line losses}} \times 100$

$$= \frac{5000}{5000 + 322.762} \times 100 = 93.936\%$$

ABCD Parameter:

Here $V_S = V_R + I_Z$

$I_S = I_R$ So, comparing with $V_S = A_{TR} + B_{TR}$

$$I_S = C_{TS} + D_{TR}$$

we have,

$$A=1, B=Z \quad i.e \quad \begin{bmatrix} A & B \\ C & D \end{bmatrix} = \begin{bmatrix} 1 & Z \\ 0 & 1 \end{bmatrix}$$

Medium transmission lines:

These are transmission Lines of Length 80km to 160 km & Operate on voltage below 20kv. Effect of capacitance are taken into consideration. The capacitance of the line is uniformly distributed over its Entire length as follows.

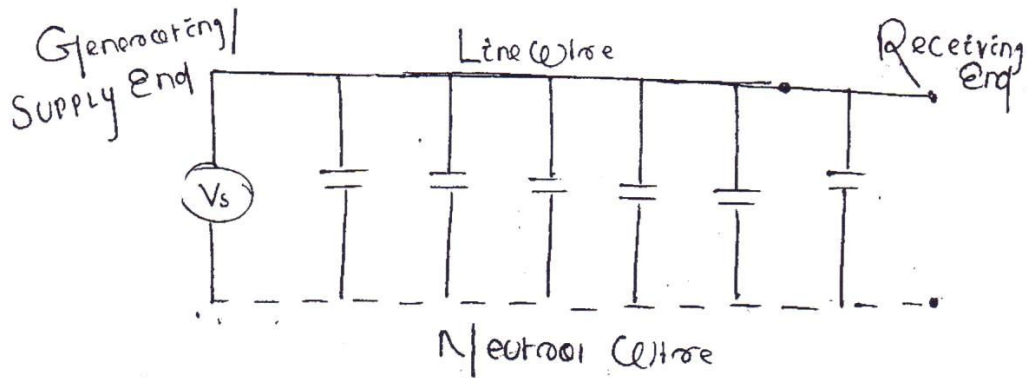

But For simple calculation, the capacitance of the system is assumed to be divided up & lumped in the form of capacitors shunted across the line at one/ more points. The Most common methods of representation localised capacitance method i.e.

- (i) End condenser Method.
- (ii) Nominal T Method (Middle condenser Method)
- (iii) Nominal π Method (Split condenser Method)

End condenser Method:

Here capacitance of the line is assumed to be lumped at the load End i.e as follows.

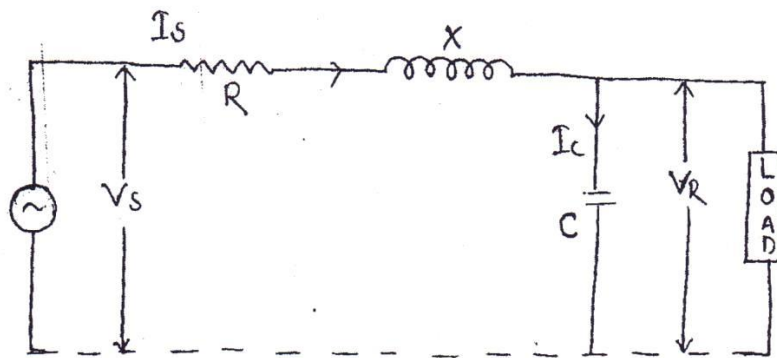

(Equivalent ckt for end condenser Method)

- Let R = Resistance of line per phase
- X = Reactance of the line per phase

C = Capacitance per phase of line in Farad.

Receiving End/ Load. End current = I_R

Receiving End voltage V_R (Phase)

$\cos(\phi_R)$ = Receiving End P.F. lagging Now.

We have,

$$V_R = V_R (1 + j0)$$

$$I_R = I_R (\cos \phi_R - j \sin \phi_R)$$

$$\text{Capacitive current } I_C = j I_R \omega C = j 2\pi f C V_R$$

$$\text{Sending End current } (I_S) = I_R + I_C$$

$$I_R (\cos \phi_R - j \sin \phi_R) + j 2\pi f C V_R$$

$$\text{Voltage drop per phase} = I_S Z = I_S (R + jX)$$

$$\text{Phase voltage at the sending end } V_S = V_R + I_S Z$$

$$\text{Percentage Regulation} = \frac{V_S - V_R}{V_R} \times 100$$

$$\text{Transmission Efficiency } (\eta) = \frac{\text{Power delivered per phase}}{\text{Power delivered per phase} + \text{Line losses / phase}}$$

$$= \frac{V_R I_R \cos \phi_R}{V_R I_R \cos \phi_R + I_S^2 R} \times 100$$

Now, we can draw phasor diagram for End. condenser method as follows.

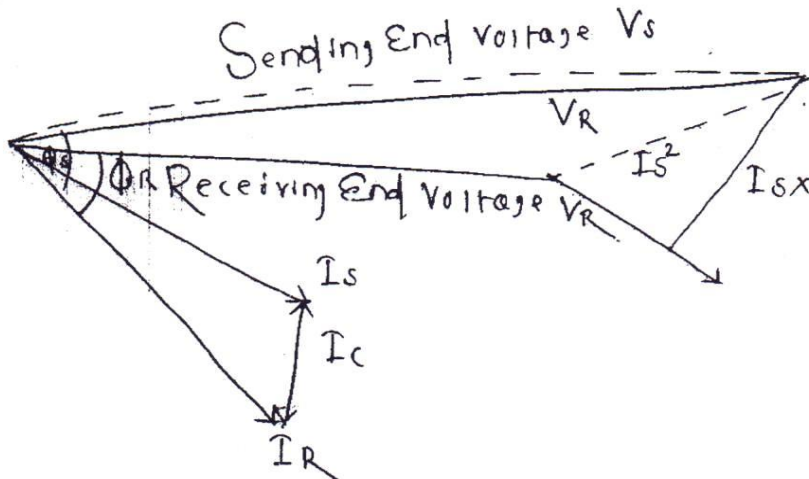

Numerical- 1 ϕ medium transmission line 80km long has the following constant Resistance per Km=0.3125 Ω , Reactance / KM=1 Ω susceptance per KM =17.5 $\times 10^{-6}$ S . Receiving End voltage 66Kv Assuming that the total capacitance of the line is localized at the receiving end alone determine.

- (i) the Sending-End current
- (ii) the Sending-End voltage
- (iii) the Sending End P.F.
- (iv) the regulation
- (v) the line losses
- (vi) Efficiency.

the line delivering 15Mw at 0.8 p.F. lagging.

Solution :

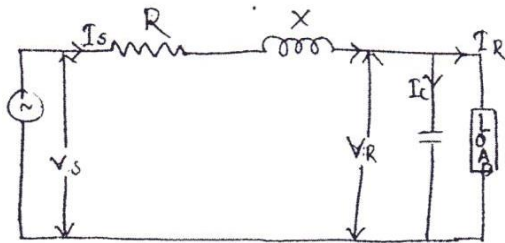

Here total Resistance (R) = 80 \times 0.3125 = 25 Ω

Total Reactance = (x) = 80 \times 1.0 = 80 Ω

Total Susceptance = (y) = 80 \times 17.5 $\times 10^{-6}$ = 14 $\times 10^{-4}$ S

Receiving End voltage $V_R = 66KV = 66,000V$

Load current $I_R = \frac{15 \times 10^6}{66,000 \times 0.8} = 284A$

Power factor at receiving End $\cos \phi_R = 0.8$ & $\sin \phi_R = 0.6$

Taking receiving End voltage V_R as reference phaser

We have, $V_R = 66,000(1 + J_0)$

$$\begin{aligned} \text{Load current } (I_R) &= 28 + (0.8 - 0.6J) \\ &= 2272 - J170.4A \end{aligned}$$

Charging current $I_c = JyV_R = J \times 0.0014 \times 66,000 = J92.4A$

(i) Sending-End current (I_s) = $I_R + I_c$

$$\begin{aligned} &= (2272 - J170.4) + J92.4 \\ &= 227.2 - J78 = 240.2 \angle -18.94A \end{aligned}$$

(ii) Sending End voltage

$$\begin{aligned} V_s &= V_R + I_s (R + Jx) \\ &= 66,000 + (227.2 - J78)(25 + J80) \\ &= 77.920 + J16.226 = 79,592 \angle 11.76V \end{aligned}$$

Sending End power factor angle $\phi_s = 11.76 - (-18.94) = 30.7$

(iii) Sending-End power factor $\cos \phi_s = \cos 30.7 = 0.86(\text{lag})$

(iv) Regulation $= \frac{V_s - V_R}{V_R} = \frac{79,592 - 66,000}{66,000} = 0.206 / 20.6\%$

(v) Line Losses $= \frac{I_s^2 R}{1000} = \frac{(2 + 0.2) \times 25}{1000} = 1442.4 \times \omega$

(vi) Transmission Efficiency $(\eta_t) = \frac{\text{Power o/p}}{\text{Power o/p} + \text{line losses}} \times 100$

$$= \frac{15,000}{15,000 + 1442.4} \times 100 = 91.23\%$$

(ii) **Nominal T Method:**

In this Method the whole of the line capacitance is assumed to be connected at the Middle Point of the line & half of the line resistance & reactance ($i.e \frac{R}{2} \& \frac{x}{2}$) to be lumped on either side as follows.

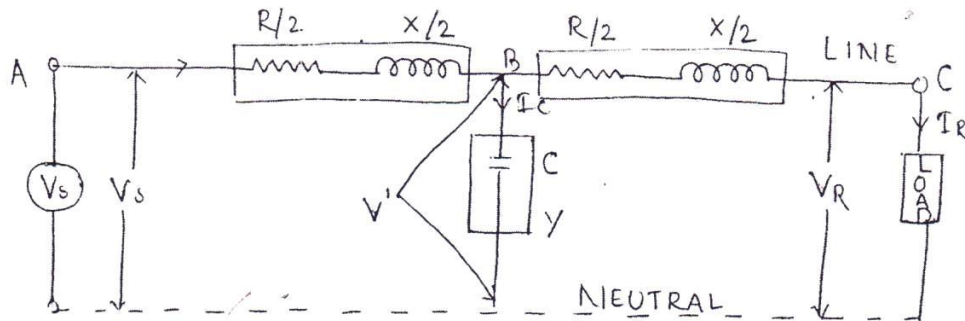

(Equivalent Circuit for Nominal-T-Method)

Here, I_R = Receiving End current
 I_C = Charging or capacitance current
 V_R = Receiving End voltage
 V_S = Sending End voltage

Now we have

$$I_s = I_R + I_C$$

Where $I_R = I_R (\cos \phi_R - j \sin \phi_R)$

$$I_C = j \omega C V' = j 2\pi F C V'$$

V' = Voltage across capacitor

$$V' = V_R + I_R \cdot \frac{Z}{2}$$

So, $I_s = I_R + j 2\pi F C V'$

$$V_s = V' + I_s \times \frac{Z}{2} = V' + I_s \frac{R + jX}{2}$$

$$\Rightarrow V_s = V' + I_s \left(\frac{R + jX}{2} \right)$$

$$\% \text{ voltage regulation} = \frac{V_s - V_R}{V_R} \times 100$$

$$\text{Transmission Efficiency } \eta_1 = \frac{V_R I_R \cos \phi_R}{V_R I_R \cos \phi_R - I_R^2 \frac{R}{2} + I_s^2 \frac{R}{2}}$$

The phasor diagram of Nominal - T method can be drawn as follows by taking V_R as Reference.

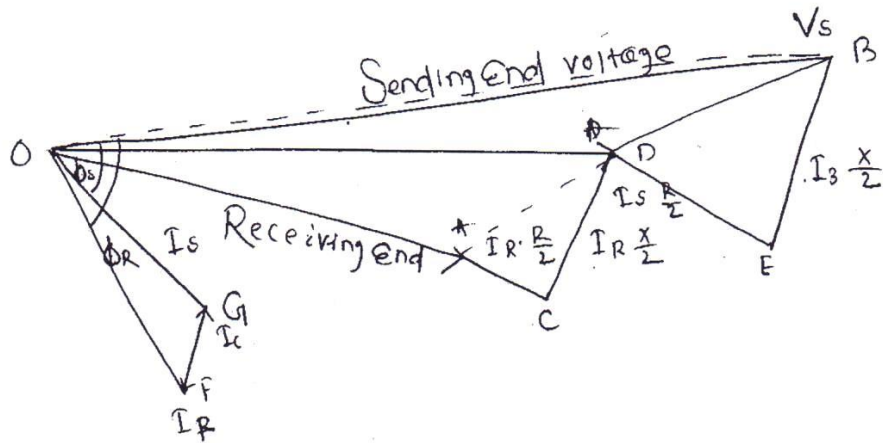

Numerical Problem :

A transmission line 280km long has the following constants.

Resistance per KM = 0.15Ω

Reactance per KM = 0.50Ω

Susceptance per km = $2.0 \times 10^{-6} \text{ mho}$

Voltage at the receiving End is 132KV. The transmission line is delivering 50MVA at 0.85PF lagging at the receiving end calculate (i) Sending End voltage (ii) Sending- End current (iii) voltage regulation (iv) Line Efficiency by Nominal T-Method.

Here Resistance of Line per phase $R = 280 \times 0.15 = 30\Omega$

Reactance of line per phase $X = 280 \times 0.50 = 100\Omega$

Capacitive Susceptance per phase $Y = 280 \times 2.0 \times 10^{-6} = 4 \times 10^{-4} S$

Receiving End line Voltage = 132KV

Receiving End phase voltage $\frac{132KV}{\sqrt{3}} = 76210v$

Load current $I_R = \frac{50 \times 10^6}{\sqrt{3} \times 132000} = 218.7A$

Line impedance $Z = R + jX = 30 + j100\Omega$

According to T-Method we have following diagram.

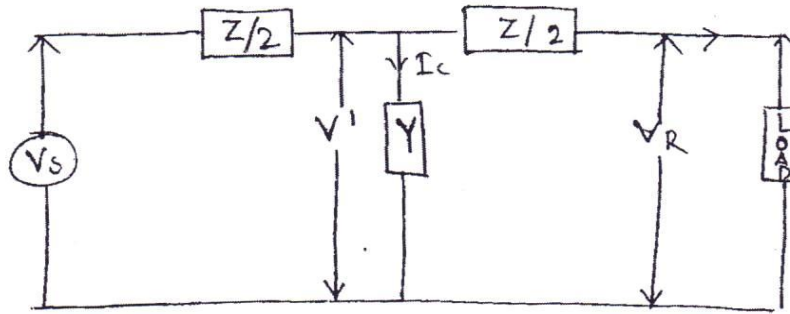

Here $V_R = 76210 + J_0$

$$\cos \phi = 0.85 \quad \sin \phi = \sqrt{1 - 0.85^2} = 0.5268$$

So, $I_R = 218.7(0.85 - J0.5268) = (185.9 - J115.2) A$

Phase voltage across condenser $V' = V_R + \frac{Z}{2} \times I_R$

$$\begin{aligned} V' &= (76210 + J0) + (185.9 - J115.2) \times \left(\frac{30 + J100}{2} \right) \\ &= 84,758.5 + J7,567V \end{aligned}$$

Charging current $I_c = V' Y = (84,758.5 + J7,567) \times J4 \times 10^{-4}$
 $= -3.0268 + J33.9 A$

Sending End current $I_s = I_c + I_R$

$$\begin{aligned} I_s &= (185.9 - J115.2) + (-3.0268 + J33.9) \\ &= 182.8732 - J81.3 = 200.13 \angle -23.97 A \end{aligned}$$

(ii) Sending End voltage $V' + I_s \times \frac{Z}{2} =$

$$\begin{aligned} &= (84,758.5 + J7,567) + \frac{1}{2}(182.87 - 81.3J)(30 + J100) \\ &= 91,566.6 + J7924.16 \\ &= 91,910 \angle 4.95V \end{aligned}$$

(iii) Sending End line voltage $= \sqrt{3} \times 91,910$
 $= 1,59191V = 159.2KV$

(iv) Voltage regulation $= \frac{V_{SL} - V_{RL}}{V_{RL}} \times 100$
 $= \frac{159.2 - 132}{132} \times 100 = 20.6\%$

(v) Line Efficiency $\eta = \frac{\sqrt{3}V_{RL} \times I_{RL} \cos\phi_R}{\sqrt{3}V_{SL} I_{SL} \cos\phi_S} \times 100$

$$\eta = \frac{\sqrt{3} \times 132 \times 218.7 \times 0.85}{\sqrt{3} \times 159.2 \times 200.13 \cos[4.95 - (-23.97)]} = 87.99\%$$

Nominal π Method

In this Method capacitance is divided & placed at beginning & Ending of the line & resistance & inductive reactance is Lumped in middle of the line as follows.

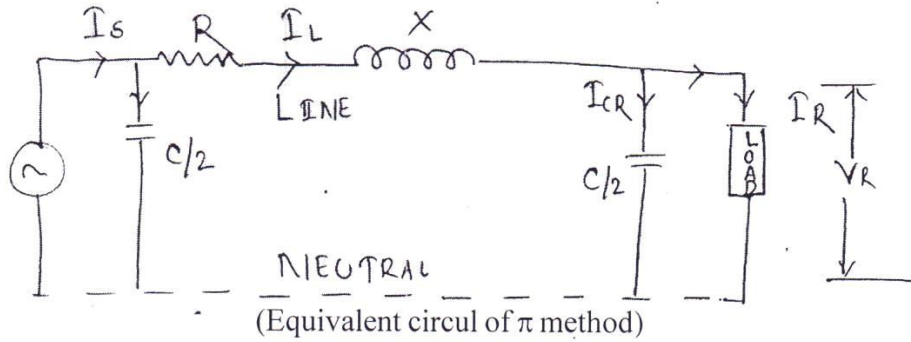

taking V_R as reference we have

Here,

$$I_{CR} = J\omega \frac{C}{2} V_R = J2\pi F \frac{C}{2} V_R$$

$$I_{CR} = I_R + I_{CR}, \quad I_R = I_L \angle -\phi_R$$

Where I_{CR} = Current through receiving End C

ϕ_R = Angle between V_R & I_R

$$I_L = \text{Line current, } I_{CS} = J\omega \frac{C}{2} V_S$$

I_{CS} = Charging current at the Sending End

$$V_S = V_R + I_L Z = V_R + I_L (R + jX)$$

$$V_S = V_R + I_L (R + jX)$$

Now phasor diagram can be sending end voltage

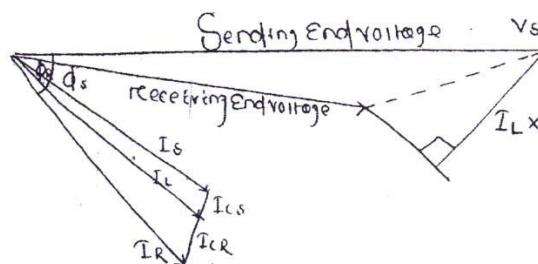

Findout the voltage regulation & efficiency following π network of 1 ϕ having following data.

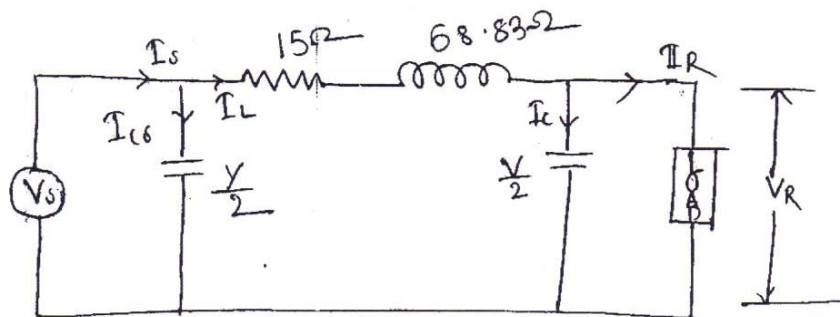

$$Y = 1.5708 \times 10^{-4} S$$

$$V_R = 22 KV$$

$$\cos \phi_R = 0.71 \text{ lagging}$$

$$S_R = 10^3 KVA$$

Solution Here $V_R = 22000 + j0$

$$I_R = \frac{S_R}{V_R} = \frac{10^3}{2} = 45.55 A$$

$$\Rightarrow I_R = 45.455(0.71 - j0.7042) \\ = (32.273 - j32) A$$

$$I_{CR} = \frac{1}{2} Y V_R = \frac{1}{2} \times (22000 \times j1.5708 \times 10^{-4}) = j1.728$$

Line current $I_L = I_R + I_{CR}$

$$= (32.273 - j32) + j1.728 \\ = (32.273 - j30.272) A = 44.24 \angle -43.16$$

Impedance drop in line $= I_L Z = (32.273 - j30.272) \times (15 + j62.83)$

$$= (2386.1 + j1573.6) V$$

Sending End voltage (V_S) $= V_R + I_L Z$

$$= 22,000 + (2386.1 + j1573.6) \\ = 24,386.1 + j1573.6 = 24.437 \angle 3.69$$

% voltage regulation $= \frac{V_S - V_R}{V_R} \times 100$

$$= \frac{24.437 - 2200}{22000} \times 100 = 11\%$$

$$\eta = \frac{10^3 \times 1000 \times 0.71}{10^3 \times 100 \times 0.71 + (44.24)^2 \times 15} = 96.02\%$$

EHV TRANSMISSION

5.1 EXPLAIN EHV AC TRANSMISSION :

Generally the voltages of 300kv to 765kv are considered as extra high voltage (EHV) transmission line. Generally EHV AC lines are selected for long distances 250km and above and high power 500mw and above. Electrical 3- ϕ EHV – AC line as follows.

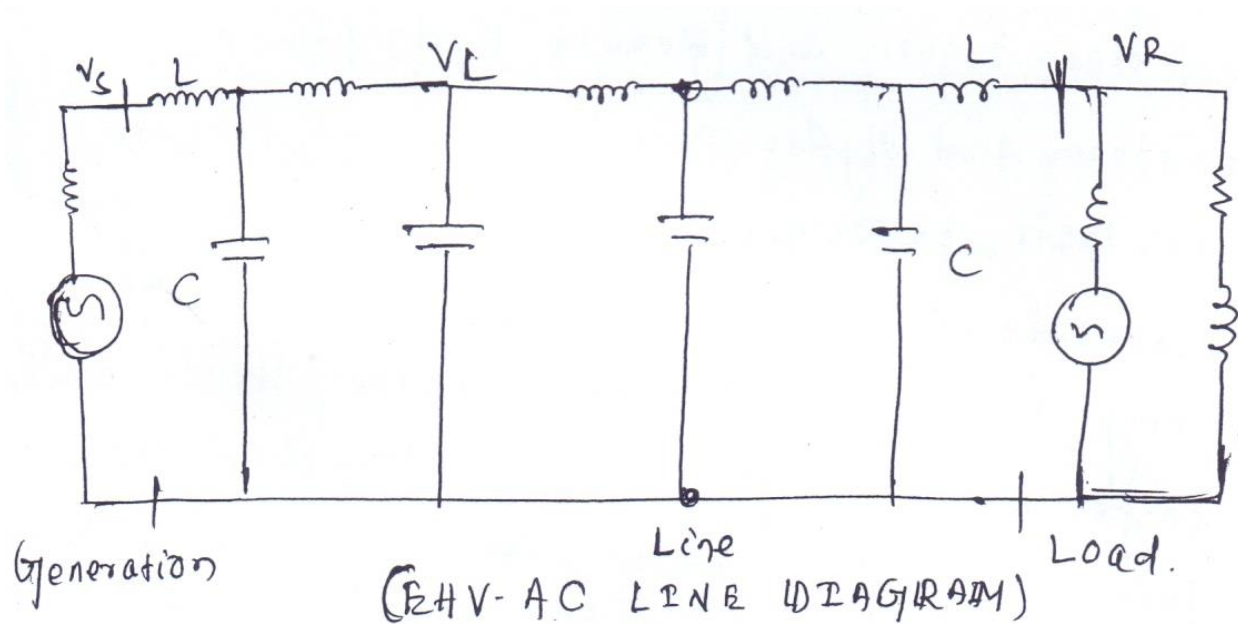

In EHV-AC line series inductance (L) and shunt capacitance C influence the performance of line (Voltage regulation power flow, stability etc.) Significantly and they can't be neglected. Here the surge impedance of the line is as follows $Z_s = \sqrt{L/C} \Omega$

Eg. 400kv- EHV-AC line has been installed in India in 1974 but recently 765 EHV AC line installed i.e. in 1992

5.2 EXPLAIN REASONS FOR ADOPTION OF EHV AC TRANSMISSION :

There are different reasons for adaption of EHV-AC transmission line as follows.

- a. Increase in size of generating units : In order to reduce the investment cost per kw, The size of generating units has been constantly increased, thus this increased large amount of power over long distances can be transmitted technically and economically in EHV transmission.

b. Pithead steam plants and remote hydro plants :-

Generally steam and hydro-power plants are located accordingly their favourable characteristics like availability of coal, water, land ,labour, transportation etc. Generally these are very far away from load centre. Hence transmission of large amount of power over long distances can only be technically and economically possible by EHV – Transmission.

- c. **Surge impedance loading :-** Surge impedance loading is the power that line carries when each phase terminated by a load equal to surge impedance of the line i.e. $Z_C = \sqrt{L/C}$

where L= Series inductance per unit length

C= shunt capacitance per unit length. Hence,

$$SIL = 3V^2/Z_C$$

Therefore voltage at higher value makes large power transmission at economic.

- d. **Transmission :** - The number of circuits and the land requirement for transmission decreases with adoption of EHV AC transmission. E.g. for transmitting 600MW over 250km at 480 line using two conductor per phase and requiring a right of way of about 40m giving $600/40 = 15\text{mw}$ per meter right of way but if it transmitted by two double circuit lines at 200kv then it requires a right of 60m giving $600/60 = 10\text{mw}$ per meter right of way. So double circuit 400kv line gives this ratio as about 30mw per meter right of way. Hence EHV line reduces right of way requirement quite substantially.
- e. **Line cost :** The line installation cost per MW per km decreases with increase in voltage level. Moreover the impact of the cost of losses on the overall transmission costs can be substantially different at different voltage levels. The total line cost including the cost of losses per mw per km decreases considerably by use of EHV AC transmission.

5.3. PROBLEMS INVOLVED IN EHV TRANSMISSION : There are different major problems associated with EHV transmission line as follows:

- a. **Corona loss and Radio Interference :** Generally corona appears in High voltage transmission line which not only a source of power loss but it is also a source of interference with radio and television.

b. Heavy supporting structure and erection difficulties :-

Generally EHV –AC transmission uses bundle conductor, Which results large mechanical loading on tower. Similarly large air and ground clearances, dynamic forces due to broken conducts etc makes large mechanical load. Hence strength of tower should be heavy.

c. Insulation requirement:- Generally EHV – AC transmission requires high insulation to withstand the voltage surges due to internal sources i.e. switching operation or due to external sources i.e lightning etc. which produces very high voltage generally 2-3 times of normal voltage. Hence insulation level depends upon switching over- voltages, temporary over- voltages and atmospheric over voltages.

5.4. HVDC TRANSMISSION : Generally high voltage DC transmission requires converter station at both sending end and receiving end. The converter station are transformers and thyristor valves. At sending end thyristor valves act as rectifier to convert ac in to dc which is transmitted over the line, whereas at the receiving end thyristor valves act as inverter to convert dc into ac which is utilized at receiving end. Each converter can function as rectifier or inverter. Thus power can be transmitted in either direction. It has following line diagram.

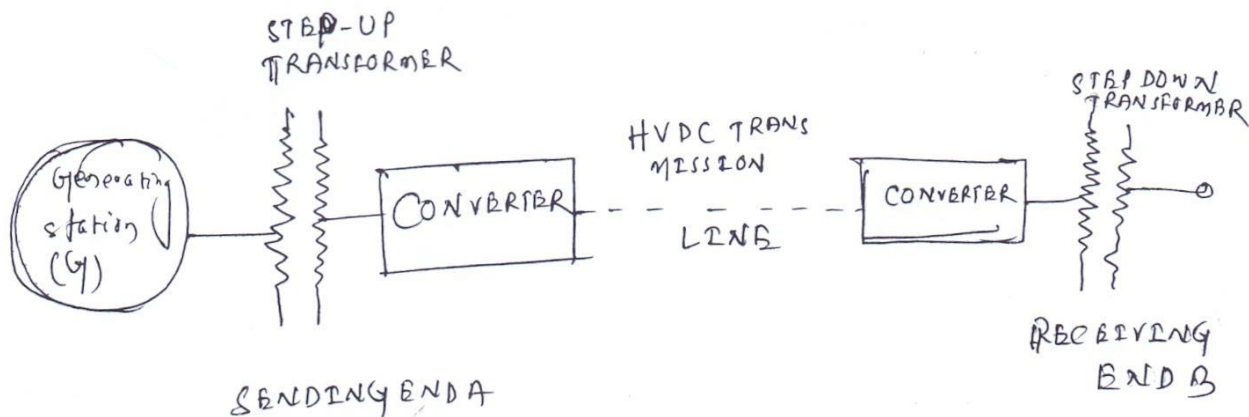

(Line diagram of typical HVDC transmission system)

The different HVDC links are as follow:-

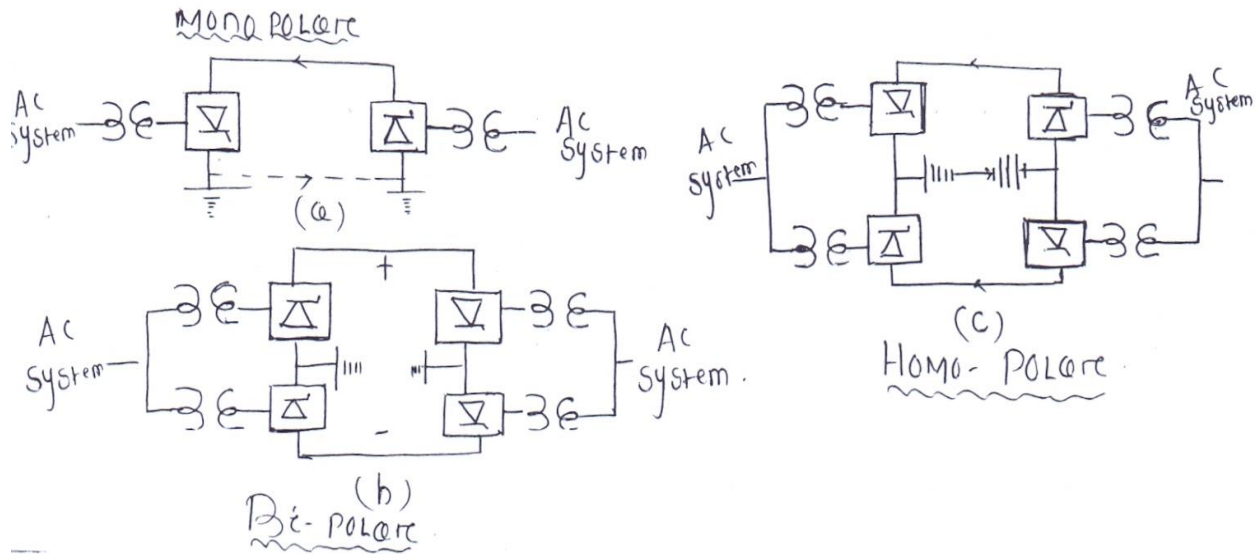

ADVANTAGES AND LIMITATIONS OF HVDC TRANSMISSION SYSTEM :

ADVANTAGES : HVDC transmission has many technical and Economics advantages over ac transmission as follows.

1. **Cheaper in cost :** Bipolar HVDC Transmission lines require two pole conductors which is very cheap.
2. **No skin effect :** As there is uniform current distribution in dc so no skin effect in HVDC.
3. **Lower transmission losses :** HVDC Transmission system needs only two conductors and therefore the power losses in a dc line is less.
4. **Voltage regulation :** Due to absence of inductance it has better voltage regulation.
5. **Line loading :** Generally loading on AC line limited by transient stability limit and line reactance but no such limit in HVDC lines. It also has no SIL with greater reliability.
6. **Low short circuit current :** It has no short circuit.
7. **Lesser corona loss and radio interference :** It has lesser corona loss due to zero frequency.
8. **Higher operating voltages and no reactive power compensation :** Generally HVDC system has high operating voltage with absence of reactive power compensation.
9. **No stability limit :** There is no stability limit in HVDC transmission system.

LIMITATIONS OF HVDC TRANSMISSION : HVDC Transmission system has following limitations as follows:

1. **Costly terminal equipment :** The converters are used in HVDC are very costly along with the converters produce lot of harmonics both on dc and ac sides, which requires filtering and smoothing equipment resulting extra additional expense. It also require complex cooling system and circuit breaker, which again adds cost.
2. **More maintenance of line insulators :** It requires more maintenance for in insulation
3. Circuit breaking in multi terminal dc system is difficult and costlier.
4. **Voltage Transformer:** Voltage transformation is not easier in case of dc and hence it has to be accomplished on the ac side of the system. DC System can't be employed for distribution sub transmission and back bone transmission.

CHAPTER-6

DISTRIBUTION SYSTEM

INTRODUCTION TO DISTRIBUTION SYSTEM :

An electric power distribution system is the final stage in the delivery of electric power. It carries electricity from transmission system to individual consumer. Distribution lines mainly sub divided in to two types.

- a. Primary distribution lines
- b. Secondary distribution lines
- a. **Primary distribution lines** : Carry the medium voltage power to distribution transformers located near the customer's premises.
- b. **Secondary distribution lines** : carry the step down voltage from the transformer located near the customer's premises to the customers.

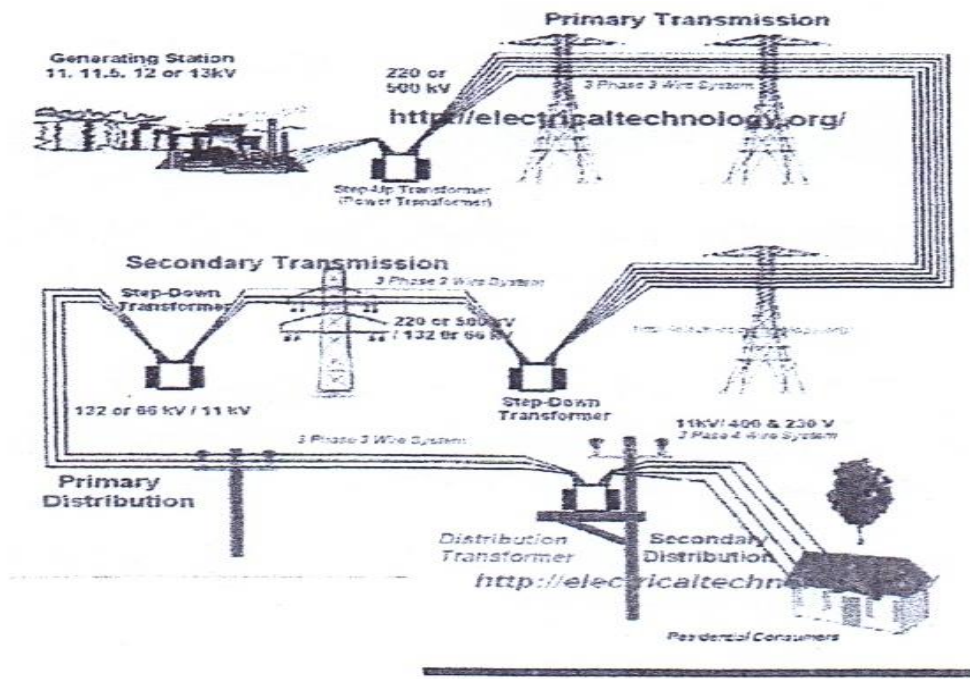

The figure shows the line diagram of a distribution system with the connection of feeders, distributor and service mains.

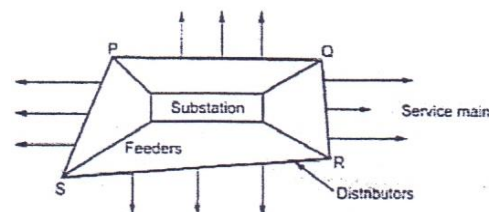

1. **Feeders :** It is a conductor which conduct electricity from substation to the area where the power is to be distributed. The feeders carries same current because no tapping are taken from the feeder. The feeder is designed according to the current carrying capacity.
2. **Distributor :** Consumers take supply from the distributor by tapping. In the above figure PQ, QR, RS, and PS are the distributor. The voltage drop along its length is considered before designing a distributor.
3. **Service mains :** It is a cable which connects the distributor to the consumer's energy meter.

Radial Electrical Power Distribution System

In early days of electrical power distribution system, different feeders were radially come out from the substation and connected to the primary of distribution transformer directly.

Radial Distribution System

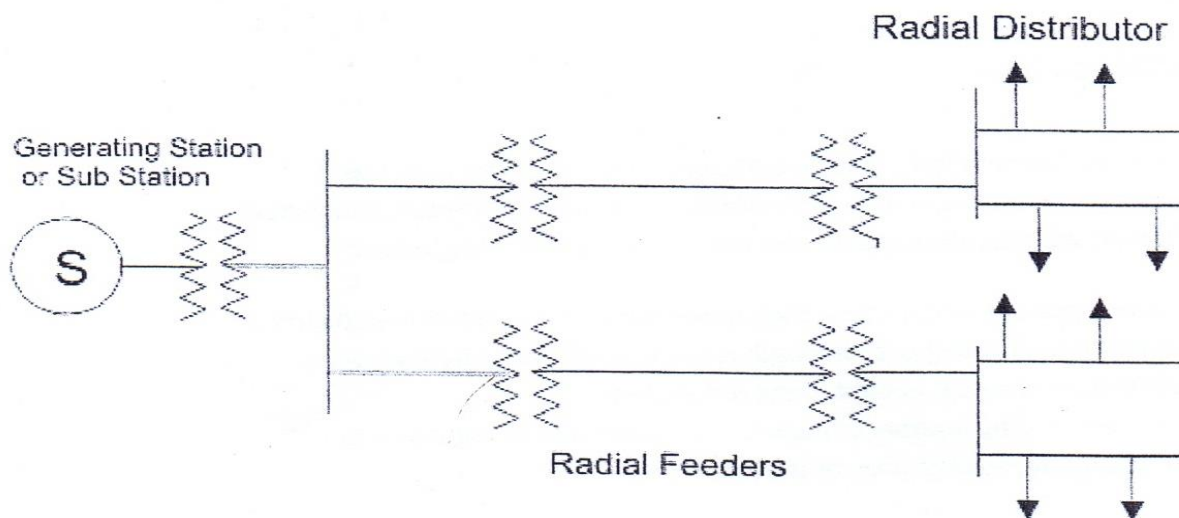

But **radial electrical power distribution system** has one major drawback that in case of any feeder failure, the associated consumers would not get any power as there was no alternative path to feed the transformer. In case of transformer failure also, the power supply is interrupted. In other words the consumer in the radial electrical distribution system would be in darkness until the feeder or transformer was rectified.

RING MAIN ELECTRICAL POWER DISTRIBUTION SYSTEM

The drawback of radial electrical power distribution system can be overcome by introducing a ring main electrical power distribution system. Here one ring network of distributors is fed by more than one feeder. In this case if one feeder is under fault or maintenance, the ring distributor is still energized by other feeders connected to it. In this way the supply to the consumers is not affected even when any feeder becomes out of service .

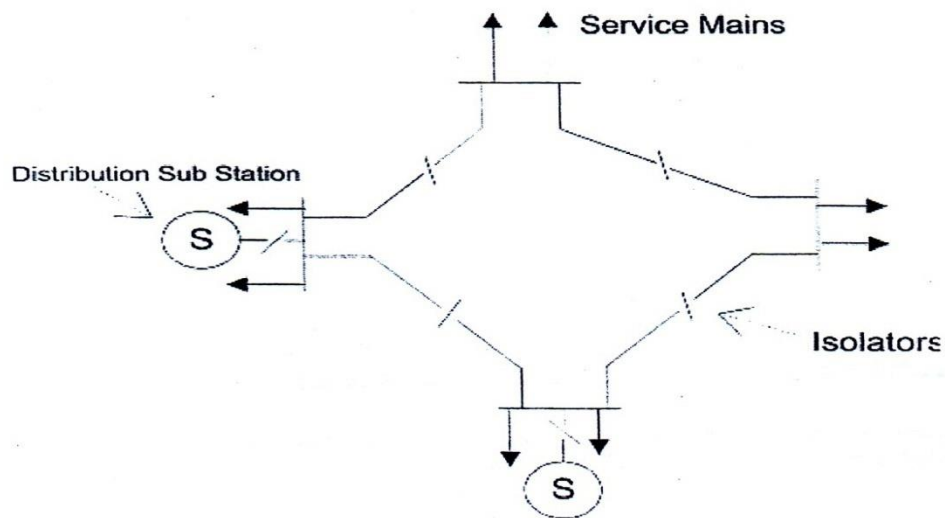

Ring Mains Distribution System

In this way, supply to the consumers connected to the healthy zone of the ring, can easily be maintained even when one section of the ring is shutdown. The number of feeders connected to the ring main electrical power distribution system depends upon the following factors.

1. **Maximum demand of the system** : If it is more, then more numbers of feeders feed the ring.
2. **Total length of the ring main distributors** : If it length is more, to compensate the voltage drop in the line, more feeders to be connected to the ring system.
3. **Required voltage regulation** : The number of feeders connected to the ring also depends upon the permissible allowable, voltage drop of the line.

The sub distributors and service mains are taken off may be via distribution transformer at different suitable points on the ring depending upon the location of the consumers. Sometimes, instead of connecting service main directly to the ring, sub distributors are also used to feed a group of service mains where direct access of ring distributor is not possible.

INTER CONNECTED SYSTEM:

In this type of system two to more than two generating station or substation are energizing the feeder ring. In this system any area from one generating station during peak load hours can be fed from other generating station which increase the efficiency of the system. Now a days electrical energy is generated, transmitted and distributed in the form of a.c. But for certain applications D.C. Supply is necessary. The D.C. Supply from the substations fed to the load through distributors.

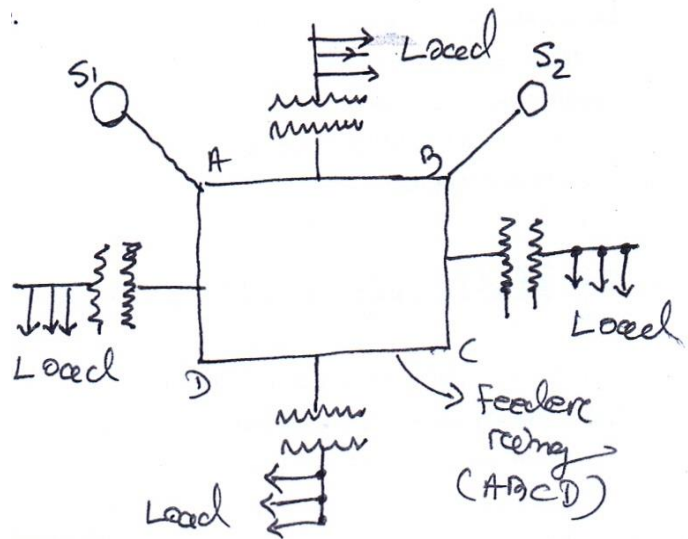

TYPES OF D.C. DISTRIBUTORS – IN SHORT

The most general method of classifying d.c. distributors is the way they are fed by the feeders. On this basis, d.c. distributors are classified as :

- Distributor fed at one end
- Distributor fed at both ends
- Distributor fed at the centre
- Ring distributor

DISTRIBUTOR FED AT ONE END:

In this type of feeding, the distributor is connected to the supply at one end and loads are taken at different points along the length of the distributor.

The current in the various sections of the distributor away from feeding point goes on decreasing. Thus current in section AC is more than the current in section CD and current in section CD is more than the current in section DE.

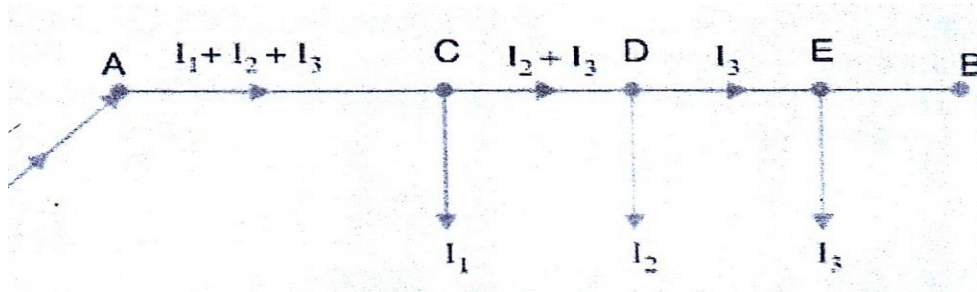

DC Distributor fed at one end

The voltage across the loads away from the feeding point goes on decreasing. In case a fault occurs on any section of the distributor the whole distributor will have to be disconnected from the supply mains. Therefore, continuity of supply is interrupted.

DISTRIBUTOR FED AT BOTH ENDS.

- In this type of feeding, the distributor is connected to the supply mains at both ends and loads are tapped off at different points along the length of the distributor.
- Here, the load voltage goes on decreasing as we move away from one feeding point say A, reaches minimum value and then again starts rising and reaches maximum value when we reach the other feeding point B. The minimum voltage occurs at some load point and is never fixed. It is shifted with the variation of load on different sections of the distributor.
- If a fault occurs on any feeding point of the distributor, the continuity of supply is maintained from the other feeding point.

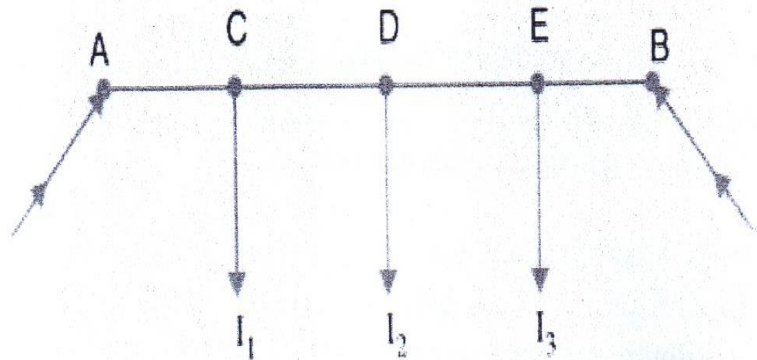

DC Distributor fed at both ends

- In case of fault on any section of the distributor, the continuity of supply is maintained from the other feeding point.
- The area of X-section required for a doubly fed distributor is much less than that of a singly fed distributor.

DISTRIBUTOR FED AT THE CENTRE.

In this type of feeding, the centre of the distributor is connected to the supply mains. It is equivalent to two singly fed distributors, each distributor having a common feeding point and length equal to half of the total length.

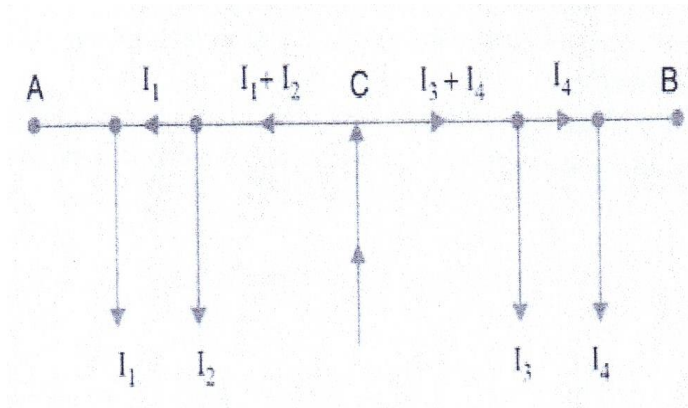

DC Distributor fed at centre

RING MAINS:

In this type, the distributor is in the form of a closed ring. It is equivalent to a straight distributor fed at both ends with equal voltages, the two ends being brought together to form a closed ring. The distributor ring may be fed at one or more than one point.

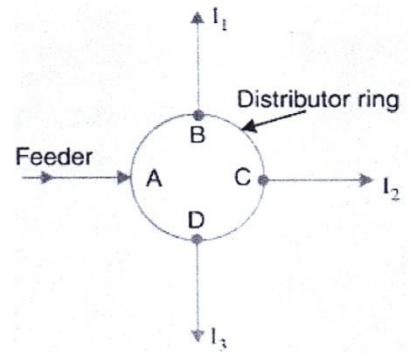

Ring Distributor

USE OF DC DISTRIBUTION

D.C. supply is required for the operation of variable speed machinery (e.g. d.c. motors), electrochemical work and electric traction. For this purpose, a.c. power is converted into d.c. power at the sub-station by using converting machinery e.g. mercury arc rectifiers, rotary converters and motor-generator sets. The d.c. supply from the sub-station is conveyed to the required places for distribution.

METHODS OF SOLVING A.C. DISTRIBUTION PROBLEMS :-

The current in different sections of the distributor will be the vector sum of load currents and not the arithmetic sum in a.c. distribution. Hence the power factor of various load currents have to be considered when solving A.C. distribution problems.

1. Power factor referred to receiving end voltage :

AB is an AC distributor where I_1 and I_2 are the loads taken from the point 'C' and 'B' as shown in fig-1. V_B is the receiving end voltage. The lagging power factor at Point 'C' is $\cos \phi_1$ and the lagging power factor at Point B is $\cos \phi_2$ w.r.t.

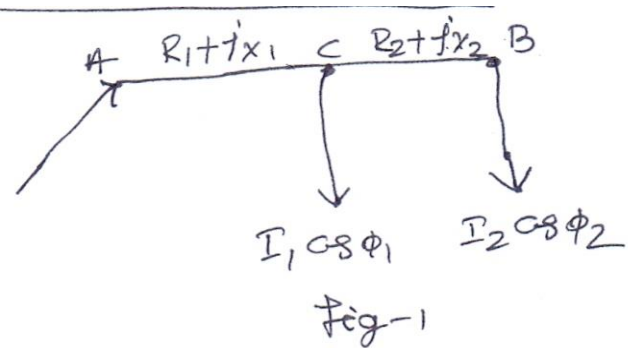

V_B . The section AC has impedance $= R_1 + jX_1$ and the section CB has the impedance $= R_2 + jX_2$. The load current at point 'C' $= I_1 = I_1(\cos \phi_1 - j \sin \phi_1)$. The load current at point 'B' is equal to current in section CB is equal to $I_{CB} = I_2 = I_2(\cos \phi_2 - j \sin \phi_2)$

The current in section AC $= I_1 + I_2$

$= I_1(\cos \phi_1 - j \sin \phi_1) + I_2(\cos \phi_2 - j \sin \phi_2)$

The current in section AC $= I_1 + I_2$

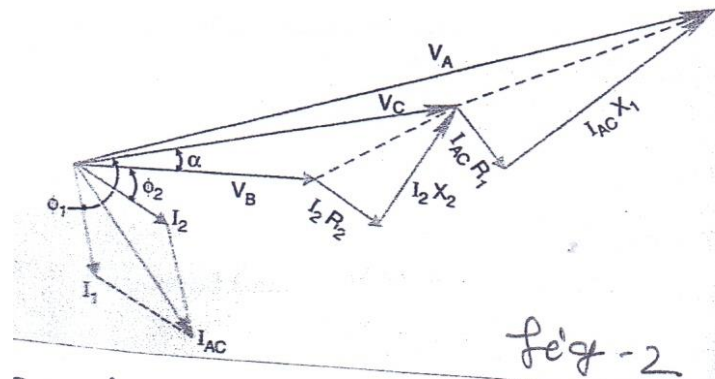

$= I_1(\cos \phi_1 - j \sin \phi_1) + I_2(\cos \phi_2 - j \sin \phi_2)$

The load current at point 'B' is equal to current in section CB is equal to $I_{CB} = I_2 = I_2(\cos \phi_2 - j \sin \phi_2)$

The current in section AC $= I_1 + I_2$

$= I_1(\cos \phi_1 - j \sin \phi_1) + I_2(\cos \phi_2 - j \sin \phi_2)$

The voltage drop in section CB $= V_{CB} = I_{CB} Z_{CB}$

$= I_2(\cos \phi_2 - j \sin \phi_2)(R_2 + jX_2)$

Voltage drop in section AC, $V_{AC} = I_{AC} Z_{AC}$
 $= (I_1 + I_2) Z_{AC}$
 $= [(I_1 \cos Q_1 - j \sin Q_1) + (I_2 \cos Q_2 - j \sin Q_2)] \times (R_1 + jX_1)$

The sending end voltage $V_A = V_B + V_{CB} + V_{AC}$

Sending end current = $I_A = I_1 + I_2$

The vector diagram of a.c. distribution when power factor referred to receiving end voltage is shown in figure -2

$V_C = V_B + (I_2 R_2)^2 + (I_2 X_2)^2$

$V_A = V_B + (I_{ac} R_1)^2 + (I_{ac} X_1)^2$

Power factor referred to respective load voltage :

If power factors of loads are referred to their respective load voltages.

Then Q_1 is the phase angle between V_C and I_1 and Q_2 is the phase angle between V_B and I_2 the vector diagram under this condition is shown in figure -2

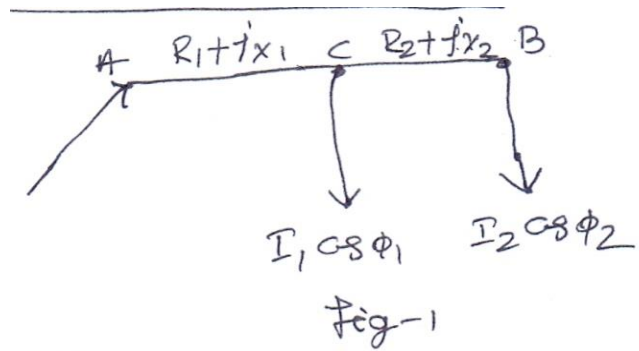

The voltage drop in section CB = $I_2 Z_{CB}$

$= I_2 (R_2 \cos Q_2 - j \sin Q_2) (R_2 + jX_2)$

Voltage at point 'C' = $V_B + \text{Drop in section CB}$

$= V_C$

$I_1 = I_1 \cos Q_1$ w.r.t. voltage V_C

$I_1 = I_1 \cos(Q_1 - R)$ w.r.t. voltage V_B

$I_1 = I_1 \cos(Q_1 - R) - j \sin(Q_1 - R)$

$I_{AC} = I_1 + I_2$

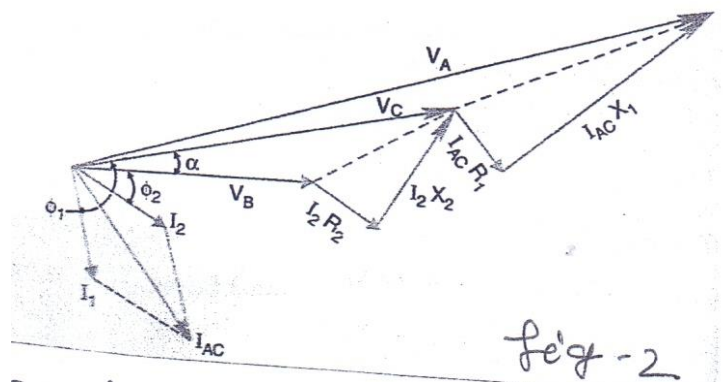

$$= I_1 \cos(\phi_1 - \theta_1) - I_1 \sin(\phi_1 - \theta_1)$$

$$+ I_2 \cos(\phi_2 - \theta_2)$$

$$\text{Voltage drop in section AC} = I_{AC} Z_{AC}$$

$$\text{Voltage at point A} = V_B + \text{Voltage drop in CB}$$

$$+ V_{ol} + \text{drop in AC}$$

3-PHASE, 4-WIRE STAR CONNECTED SYSTEM:-

In this system 4-wires are connected in a circuit. There are three phase wires and a neutral wire. The phases are electrically 120 degrees apart from each other. All the 3-phases meeting at a point known as neutral point. The wire connected to the neutral point is known as neutral wire. The voltage between any one phase and neutral line is known as

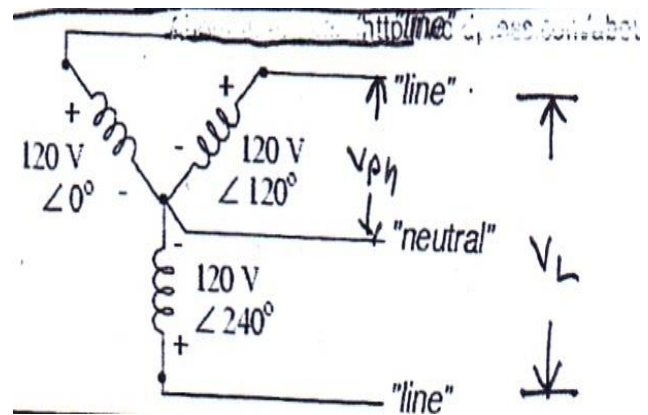

phase voltage (V_{ph}). The voltage between the two line is known as line voltage (V_L) in a star connection the line voltage is $\sqrt{3}$ times greater than phase voltage. But the line current is same as the phase current. Most of the A.C. machines are star connected.

CHAPTER-7

UNDER GROUND CABLES

INTRODUCTION

Since the loads having the trends towards growing density. This requires the better appearance, rugged construction, greater service reliability and increased safety. An underground cable essentially consists of one or more conductors covered with suitable insulation and surrounded by a protecting cover. The interference from external disturbances like storms, lightning, ice, trees etc. should be reduced to achieve trouble free service. The cables may be buried directly in the ground, or may be installed in ducts buried in the ground.

ADVANTAGES & DISADVANTAGES

Advantages

- ≈ Better general appearance
- ≈ Less liable to damage through storms or lightning
- ≈ Low maintenance cost
- ≈ Less chances of faults
- ≈ Small voltage drops

Disadvantages :

- ≈ The major drawback is that they have greater installation cost and introduce insulation problems at high voltages compared with equivalent overhead system.

Properties of insulation materials for cables :-

The properties are

1. High resistivity
2. High mechanical strength
3. High dielectric strength
4. Not affected by acid or alkalis

5. Non- inflammable
6. High tensile strength
7. Low cost

INSULATING MATERIALS USED IN UNDER GROUND CABLES :-

The insulating materials used in underground cables are.

1. Rubber
2. VIR
3. Impregnated paper
4. PVC
5. Varnished cambric

1. Rubber :

It is the most commonly used insulating material. Natural rubber is produced from the latex of the rubber tree. Synthetic rubber is produced from alcohol or oil products. It absorbs moisture slightly and is soft. Therefore pure rubber cannot be used as an insulating material.

VULCANIZED INDIA RUBBER (VIR):

It is used for low voltage power distribution systems only. It is prepared by mixing pure rubber with mineral matter such as sulphur, zink oxide, red lead etc. it has greater mechanical strength than pure rubber. The advantages of using this type of rubber for cable is that, the cable becomes strong and more curable before using VIR as insulation, the copper conductor must be tunnel well because it attacks copper. (Reacts copper) its use is limited because of its low melting point and short span of life.

IMPREGNATED PAPER :

It has low capacitance, high dielectric strength and economical. The paper is manufactured with wood pulp, rags or plant fiber by a suitable chemical process. It has high resistance due to high resistivity center dry condition. It absorbs a small amount of moisture only, which reduced the insulation resistance. For this drawback it requires some sort of protective covering. It is impregnated in insulating oil before used.

POLYVINYL CHLORIDE (PVC):

It is a synthetic compound material. It is obtained from the polymerization of acetylene and is in the form of white powder. It is combined chemically with a plastic compound and is used over the conductor as an insulation cover. It has high insulation resistance, good dielectric strength. PVC insulated cables are usually employed for medium and low voltage domestic insulation.

VARNISHED CAMBRIC :-

It is the cotton cloth impregnated and coated with varnish. The cambric is lapped on the conductor in the form of a tape and its surface are coated with petroleum jelly compound to allow for the sliding of one turn over another as the cable is bent.

CLASSIFICATION OF CABLES :

Mainly underground cables are classified in two ways.

1. According to the type of insulating materials used in their manufacture
2. The voltage for which they are manufacture
3. No of conductors used in cable
4. Power to be handled in cable.

CLASSIFICATION OF CABLES

Things may be classified on many aspects and similar is the case with cables. There are several ways of classifying cables. These includes classification of cables on the basis of

- No. of Conductors in Cable
- Voltage Rating of Cable
- Insulation Used in Cable
- Power To Be handled in Cable

No. of Conductors in Cable

On the basis of number of conductors in the cable, cables are of two types viz Single core cables and 3 core cables. Single core cable have only one conductors and the diagram is shown in Underground Cable Basics while three core cable has three conductors and they have bedding and filler too.

so on the basis of number of conductors cables are of two types

- Single Core Cable
- 3 Core Cable

Voltage Rating of Cable

Cables may be classified on the basis of voltage rating also

- LT Cables : Cables up to 1000 Volts or 1 kV are called LT (Low Tension) or LV (Low Voltage) cables
- HT Cables : Cables from 1001 volts to 11000 Volts or 11kV are called HT (High Tension) or HV (High Voltage) cables.
- ST Cables : Cables from 11001 volts to 33000 Volts or 33kV are called ST (Super Tension) cables.
- EHV Cables : Cables from 33001 volts to 66000 Volts or 66kV are called EHT (Extra High Tension) or EHV
- Oil & Gas Filled Cables : From 66 kV to 132 kv Oil and Gas Filled cables are used.
- EST Cables : Cables used above 132 W are called EST (Extra Super Tension) cables.

Insulation Used in Cable

Cables are also classified on the basis of insulation provided in the cable. Following are the type of cables on the basis of insulation used in the cable -

- PIC or PILC : Paper Insulated Cable - Paper is used as insulation to the conductor.
- PVC : Poly Vinyl Chloride Cable - PVC is used as insulation to the conductor.

- PE : Poly Ethylene - Poly Ethylene is used as insulation to the conductor
- PTFE : Poly Tetra Fluoro Ethylene - PTFE is used as insulation to the conductor
- XLPE : Cross Linked Poly Ethylene - Cross Linked Poly Ethylene is used as insulation.
This is most commonly used cable in Industry.

Power to Be handled in Cable

On the basis of amount of power to be transferred through the cable, cables are classified into two categories. These are

- **Power Cables :** If large amount of power is to be transferred then these are called power cables. These are further classified on the basis of voltage at which power is to be delivered.
 1. **Low Voltage Power Cable :** If the voltage in the cable is less than 1000 Volts or 1 kV then the cable is called Low Voltage Power Cable.
 2. **High Voltage Power Cable :** If the voltage in the cable is above 1000 Volts or 1 kV then the cable is called High Voltage Power Cable.
- **Control Cables:** If the cable is used to carry very low power signal generally for controlling equipments then the cables are called control cables.

1. **Low tension cables (L.T. cables) :**

These are used for the voltage levels up to 6.6kv. The electrostatic stresses in L.T. cables are not severe hence no special construction is used for L.T. cables. The paper is used as an insulation in these cables. Sometimes resin is also used which increases the viscosity and helps to prevent drainage.

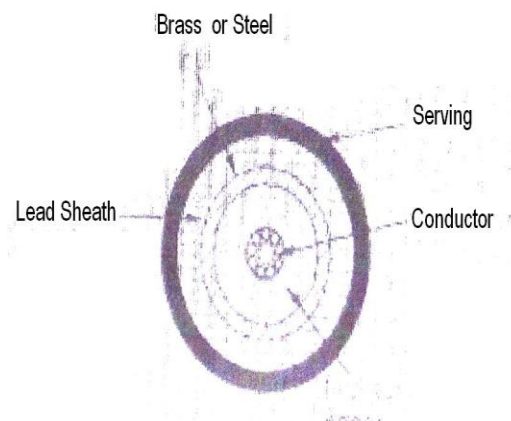

The Fig. 5.2 shows the cross-section of a single core L.T. cable. It consists of a circular core of stranded copper or aluminum. The conductor is insulated by impregnated paper. Over the paper insulation, the lead sheath is provided. Then a layer of compounded fibrous material is provided. Then armoring is provided and finally covered again with a layer of fibrous compounded material. Many a times, L.T. cables are not provided with armoring, to avoid excessive sheath losses. The simple construction and the availability of more copper section are the advantages of L.T. single core cable.

H.T. Cable :-

H.T. cables are the cables which are used for voltage levels up to 11kv.

Construction :-

The cores are not circular in shape. The cores are insulated from each other by layers of impregnated papers. It has 3 – cores. The three cores are grouped together and belted with the help of a paper belt. The gaps are filled with fibrous materials like jute. This gives circular cross sectional shape to the cable. The belt is covered with lead sheath which protect cable from moisture and also give mechanical strength. The

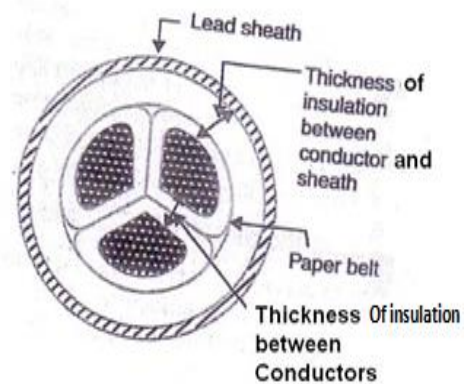

belted type construction is suitable only for low and medium voltages. Under high voltage cases, the cumulative effect of tangential electrical stress is to form spaces inside the cable due to leakage currents. Such air spaces formed inside the insulation is called void formation. Under high voltage, spaces are ionized which deteriorate the insulation which may lead to the breakdown of the insulation. Hence belt cables are not used for the high voltage levels.

METHODS OF CABLE LYING :

There are three main methods used for laying underground cables.

1. Direct laying.
2. Draw-in system
3. Solid system

2. Direct laying :

The above figure shows how the cable is laying in this method. A trench of about 1.5 meter deep and 45cm wide is dug. Then the trench is covered with a layer of fine sand, about 10cm thick the cable is laid over the sand. The sand does not allow the entry of moisture from the ground. Then the cable is covered with another layer of sand of about 10cm thickness.

After that the trench is covered with bricks and other materials to protect the cables from mechanical injury. When more than one cable is to be laid in the same trench, a horizontal or vertical inter axial spacing of at least 30cm is provided in order to reduce the effect of mutual heating. This method of laying under ground cables is simple and cheap.

3. Draw- in system :

This method of cable laying suitable for congested areas where excavation is inconvenient. In this method a line of conduits, ducts or tubes made of either iron, glazed stoneware clay or cement concrete are laid in ground with manholes at suitable positions along the cable route. The cables are then pulled in to position. Separate pipes and ducts are provided for each cable laid in the same duct. Care must be taken that where the duct line changes direction, depths, etc. so that a large cable may be pulled easily between the manholes. The distance between the manholes should not be too long so as to simplify the pulling in the cables.

SOLID SYSTEM :

In this method the cable is laid in open pipes or troughs dug out in earth along the cable route. The toughing is of cast iron, stoneware, asphalt or treated wood. After laying the cable in position, the toughing is filled with a bituminous and covered over.

METHODS OF LOCATION OF CABLE FAULTS:

Several methods are used for locating the faults in underground cables. The most popular methods for locating faults in underground cables known as loop tests. These are as follows.

1. Murray loop test
2. Varley loop test

1. Murray loop test :

This test is the common and accurate method of locating earth fault or short – circuit fault in underground cables.

a. Earth fault :

The figure shows the circuit diagram of locating the earth fault by Murray loop test. Fault by Murray loop test. Here AB is the sound cable and CD is the faulty cable and the earth fault occurring at the point F.

The end of fault cable at point 'D' is connected with the point 'B' of the sound cable with a low resistance. Two variable resistances P and Q are connected to ends A and C

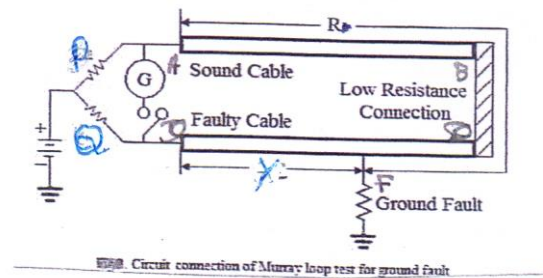

Let R = Resistance of the conductor loop from the test end to the point 'F' where the fault occur

X = Resistance from fault point 'F' to the rest of the faulty cable 'C'

The resistance P and Q are varied till the galvanometer indicates zero.

The balanced position of the Wheatstone bridge where P,Q,R & X are the four arms is $P/Q = R/X$

Or $P/Q + 1 = R/X + 1$

$$\text{Or } P+Q/Q = R+X/X$$

If 'R' is the resistance of each cable

$$\text{Then } R+X = 2r$$

$$\text{So } P+Q/Q = 2r/X$$

$$X = Q/P+Q \times 2r$$

If 'L' is the length of each cable in meter

Then resistance per meter length of cable = r/L

Distance of fault point from test end is

$$D = x/(r/l)$$

Putting the values of x in the above equation

$$D = Q/P+Q \times 2r \times L/r$$

$$= Q/P+Q \times 2L$$

[$D = Q/P+Q \times \text{loop length in meter}$]

B SHORT – CIRCUIT FAULT :

In the circuit shown P,Q,R & X are the four arms of the bridge. The fault resistance is in the battery circuit. the bridge is balanced by adjusting the resistances 'P' and 'Q' in balanced condition.

$$P/Q = R/X$$

$$P/Q+1 = R/X +1$$

$$P+Q/Q = R+X/X$$

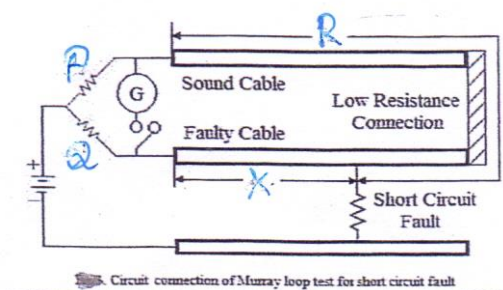

Circuit connection of Murray loop test for short circuit fault

If 'R' is the resistance of each cable

Then $R+X = 2r$

So $P+Q/Q = 2r/X$

$X = Q/P+Q \times 2r$

If 'L' is the length of each cable in meter

the resistance per meter length of cable = r/L

Distance of short-circuit fault point from test end is

VARLEY LOOP TEST :

It is also used for locating earth fault or short-circuit fault in underground cables. This test can be done with the help of Wheatstone bridge principle.

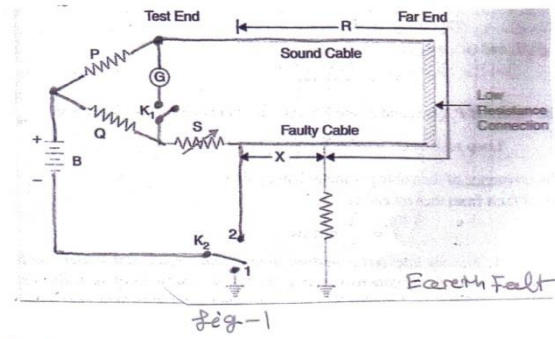

In this test P and Q are the fixed resistances and the balance can be done by varying the variable resistance S.

For earth fault or short circuit fault, the key 'K₂' is connected to position-I. After that the variable resistance S is varied till the bridge is balanced for resistance value S₁.

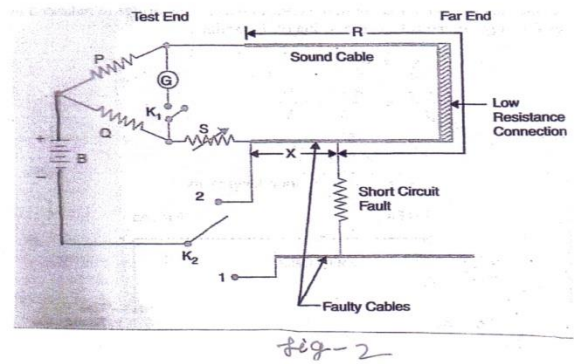

So $P/Q = R/X+S_1$, $P/Q+1 = (R/X+S_1)+1$

$P+Q/Q = (R+X+S_1)/(X+S_1)$

$X = Q (R+X) - PS_1 / P+Q \dots\dots\dots(1)$

Then the key K_2 is connected to position – 2 and the bridge is balance to a new value of resistance

$$P/Q = R+X/S_2 \quad , \quad (R+X) Q = PS_2 \dots\dots\dots(2)$$

From equation 1 & 2 we will get $X = P(S_2-S_1)/P+Q$

The loop resistance = $R+X = (P/Q)S_2$

If 'r' is the resistance of the cable per meter length. The distance of fault from the test end is $D = X/r$ meters.

CHAPTER-8

CAUSES OF LOW POWER FACTOR

The main cause of low Power factor is Inductive Load. As in pure inductive circuit Current lags 90° from Voltage, this large difference of phase angle between current and voltage causes zero power factor. Basically, all those circuit having Capacitance and inductance (except resonance circuit (or Tune Circuit) where inductive reactance = capacitive reactance ($X_L = X_C$), so the circuit becomes a resistive circuit), power factor would be exist over there because Capacitance and inductance causes in difference of phase angle (ϕ) between current and voltage.

there are a lot of disadvantages of low Pf and we must improve Pf .

FOLLOWING ARE THE CAUSES OF LOW POWER FACTOR:

1. **Single phase and three phase induction Motors** (Usually, Induction motor works at poor power factor i.e. at:

Full load, Pf= 0.8 - 0.9

Small load, Pf = 0.2 - 0.3

No Load, Pf may come to Zero (0).
2. **Varying Load in Power System** (As we know that load on power system is varying. During low load period, supply voltage is increased which increase the magnetizing current which cause the decreased power factor)
3. **Industrial heating furnaces**
4. **Electrical discharge lamps** (High intensity discharge lighting) Arc lamps (operate a very low power factor)
5. **Transformers**
6. **Harmonic Currents**

You may also read about:

- Power Factor
- Active, Reactive, Apparent and Complex Power. Simple explanation with formulas.
- Disadvantages of Low Power Factor
- Power Factor improvement Methods with Their advantages & Disadvantages
- Advantages of Power factor improvement and Correction
- How to Calculate the Suitable Capacitor Size in Farads & kVAR for Power factor improvement (Easiest way ever)
- How to Convert Capacitor Farads into kVAR and Vice Versa (For Power factor improvement)

DISADVANTAGES OF LOW POWER FACTOR:

Power factor play an important role in AC circuits and power dissipation depends on this factor. For instant, we know that;

Power in a Three Phase AC Circuit = $P = \sqrt{3} V \times I \cos\phi$

And Current in a Three Phase AC Circuits = $I = P / (3 V \times \cos\phi)$

$I \propto 1 / \cos\phi \dots\dots(1)$

Also,

Power in a Single Phase AC Circuits = $P = V \times I \cos\phi$

And Current in a Three phase AC Circuits = $I = P / (V \times \cos\phi)$

$I \propto 1 / \cos\phi \dots\dots(2)$

It is clear from both equations (1) and (2) that Current “I” is inversely proportional to $\cos\phi$ i.e. Power Factor.

In other words, When Power Factor increases, Current Decreases, and when Power Factor decreases, Current Increases.

Now, in case of Low Power Factor, Current will be increased, and this high current will cause to the following disadvantages.

1.) Large Line Losses (Copper Losses):

We know that Line Losses is directly proportional to the square of Current I^2

Power Loss = $I^2 \times R$ i.e., the larger the current, the greater the line losses i.e. $I \gg$ Line Losses

In other words,

Power Loss = $I^2 \times R = 1/\cos^2 \phi$ Refer to Equation "1.1 / $\cos \phi$ "(1)

Thus, if Power factor = 0.8, then losses on this power factor = $1/\cos^2 \phi = 1/0.8^2 = 1.56$ times will be greater than losses on Unity power factor.

2.) Large kVA rating and Size of Electrical Equipments:

As we know that almost all Electrical Machinery (Transformer, Alternator, Switchgears etc) rated in kVA. But, it is clear from the following formula that Power factor is inversely proportional to the kVA i.e.

$$\cos \phi = kW / kVA$$

Therefore, The Lower the Power factor, the larger the kVA rating of Machines also, the larger the kVA rating of Machines, The larger the Size of Machines and The Larger the size of Machines, The Larger the Cost of machines.

3.) Greater Conductor Size and Cost:

In case of low power factor, current will be increased, thus, to transmit this high current, we need the larger size of conductor. Also, the cost of large size of conductor will be increased.

4.) Poor Voltage Regulation and Large Voltage Drop:

Voltage Drop = $V = IZ$.

Now in case of Low Power factor, Current will be increased. So the Larger the current, the Larger the Voltage Drop.

Also Voltage Regulation = $V.R = (V_{\text{No Load}} - V_{\text{full Load}}) / V_{\text{full Load}}$

In case of Low Power Factor (lagging Power factor) there would be large voltage drop which cause low voltage regulation. Therefore, keeping Voltage drop in the particular limit, we need to install Extra regulation equipments i.e. Voltage regulators.

5.) Low Efficiency:

In case of low Power Factor, there would be large voltage drop and large line losses and this will cause the system or equipments efficiency too low. For instant, due to low power factor, there would be large line losses; therefore, alternator needs high excitation, thus, generation efficiency would be low.

6.) Penalty from Electric Power Supply Company on Low Power factor

Electrical Power supply Company imposes a penalty of power factor below 0.95 lagging in Electric power bill. So you must improve Pf above 0.95.

METHODS FOR POWER FACTOR IMPROVEMENT

The following devices and equipments are used for Power Factor Improvement.

1. Static Capacitor
2. Synchronous Condenser
3. Phase Advancer

I. STATIC CAPACITOR

We know that most of the industries and power system loads are inductive that take lagging current which decrease the system power factor (See Disadvantages of Low Power factor) . For

Power factor improvement purpose, Static capacitors are connected in parallel with those devices which work on low power factor. These static capacitors provides leading current which neutralize (totally or approximately) the lagging inductive component of load current (i.e. leading component neutralize or eliminate the lagging component of load current) thus power factor of the load circuit is improved. These capacitors are installed in Vicinity of large inductive load e.g Induction motors and transformers etc, and improve the load circuit power factor to improve the system or devises efficiency.

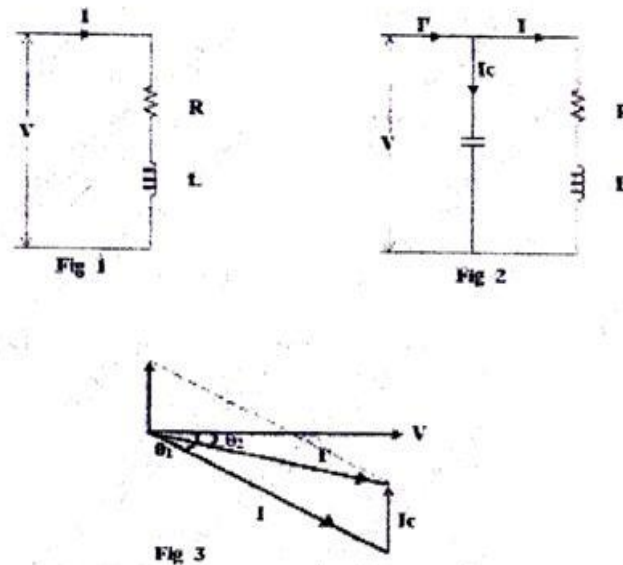

Suppose, here is a single phase inductive load which is taking lagging current (I) and the load

power factor is $\cos\theta$ as shown in fig-1.

In fig-2, a Capacitor (C) has been connected in parallel with load. Now a current (I_c) is flowing through Capacitor which lead 90° from the supply voltage (Note that Capacitor provides leading Current i.e., In a pure capacitive circuit, Current leading 90° from the supply Voltage, in other words, Voltage are 90° lagging from Current). The load current is (I). The Vectors combination of (I) and (I_c) is (I') which is lagging from voltage at θ_2 , as shown in fig 3.

It can be seen from fig 3 that angle of $\theta_2 < \theta_1$ i.e. angle of θ_2 is less than from angle of θ_1 .

Therefore $\cos\phi_2$, is less than from $\cos\phi_1$ ($\cos\phi_2 > \cos\phi_1$). Hence the load power factor is improved by capacitor.

Also note that after the power factor improvement, the circuit current would be less than from the low power factor circuit current. Also, before and after the power factor improvement, the active component of current would be same in that circuit because capacitor eliminates only the re-active component of current. Also, the Active power (in Watts) would be same after and before power factor improvement.

Advantages:

- Capacitor bank offers several advantages over other methods of power factor improvement.
- Losses are low in static capacitors
- There is no moving part, therefore need low maintenance
- It can work in normal connotations (i.e. ordinary atmospheric conditions)
- Do not require a foundation for installation
- They are lightweight so it is can be easy to installed

Disadvantages:

- The age of static capacitor bank is less (8 - 10 years)
- With changing load, we have to ON or OFF the capacitor bank, which causes switching surges on the system
- If the rated voltage increases, then it causes damage it
- Once the capacitors spoiled, then repairing is costly

2. SYNCHRONOUS CONDENSER

When a Synchronous motor operates at No-Load and over-excited then it's called a synchronous Condenser. Whenever a Synchronous motor is over-excited then it provides leading current and works like a capacitor. When a synchronous condenser is connected across supply voltage (in parallel) then it draws leading current and partially eliminates the re-active component and this

way, power factor is improved. Generally, synchronous condenser is used to improve the power factor in large industries.

Advantages

- Long life (almost 25 years)
- High Reliability
- Step-less adjustment of power factor.
- No generation of harmonics of maintenance
- The faults can be removed easily
- It's not affected by harmonics.

Require Low maintenance (only periodic bearing greasing is necessary)

Disadvantages

- It is expensive (maintenance cost is also high) and therefore mostly used by large power users.
- An auxiliary device has to be used for this operation because synchronous motor has no self starting torque
- It produces noise

3. PHASE ADVANCER

Phase advancer is a simple AC exciter which is connected on the main shaft of the motor and operates with the motor's rotor circuit for power factor improvement. Phase advancer is used to improve the power factor of induction motor in industries. As the stator windings of induction motor takes lagging current 90° out of phase with Voltage, therefore the power factor of induction motor is low. If the exciting ampere-turns are excited by external AC source, then there would be no effect of exciting current on stator windings. Therefore the power factor of induction motor will be improved. This process is done by Phase advancer.

Advantages

- Lagging kVAR (Reactive component of Power or reactive power) drawn by the motor is sufficiently reduced because the exciting ampere turns are supplied at slip frequency (f_s).
- The phase advancer can be easily used where the use of synchronous motors is Unacceptable

STABILITY VARIATION IN LINE VOLTAGE

1. Over Loading
2. Improve System Stability

LOAD CURVE

Load curve is a graph with time on x-axis & load megawatt on y-axis.

Load curves are drawn for a generating station or group of generating stations connected to each other to feed a group of load.

Note :- Here time can be taken as hour, Day, week, month or year.

Power :- Power is always taken in megawatt

Types of load curve :-

1. Daily load curves :-

Daily load variation in load from time to time is plotted on a graph taking load on y-axis or time on x-axis

2. Weekly load curve

In this curve seven days of week on x-axis & load on y-axis

3. Monthly load curve :-

The curve in which weeks of a month is taken on x-axis & load on y-axis (optional load curve)

4. Yearly load curve :

The curves in which months are taken on x-axis & average load of a month are taken on y-axis.

The load curves for Sunday other week days of summer & winter seasons for a typical metro Politian area as shown in above.

Explanation of Load Curve

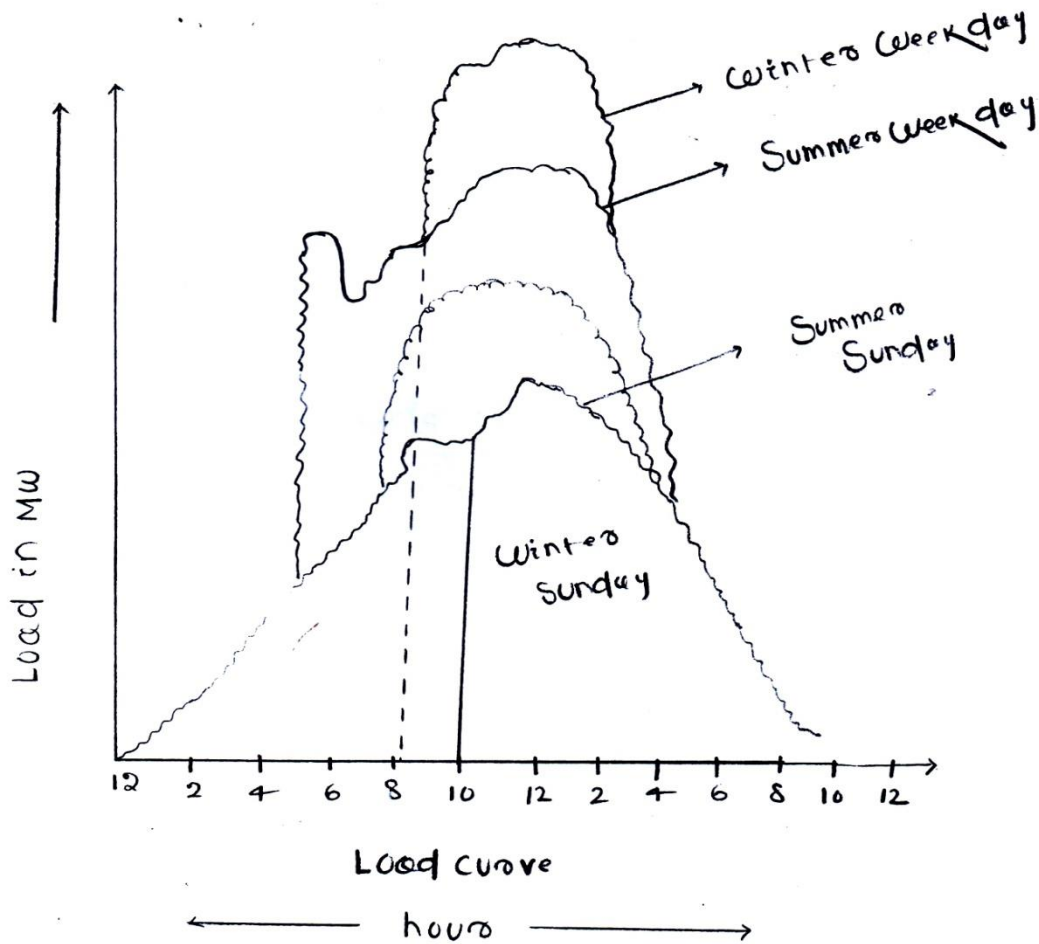

Here during early morning hours demand low & around 5 am. The load starts increasing because of increasing industrial & traction load around 9 am the load reaches at high value & remain almost constant till evening except lunch hours & load again starts increasing due to residential & traction load 7 to 9 pm peak occurs load starts decreasing but Sunday load demand less as compared any other week days.

The information obtained from daily load curve if we plot the load against hour in a day for a power station we will gate following below.

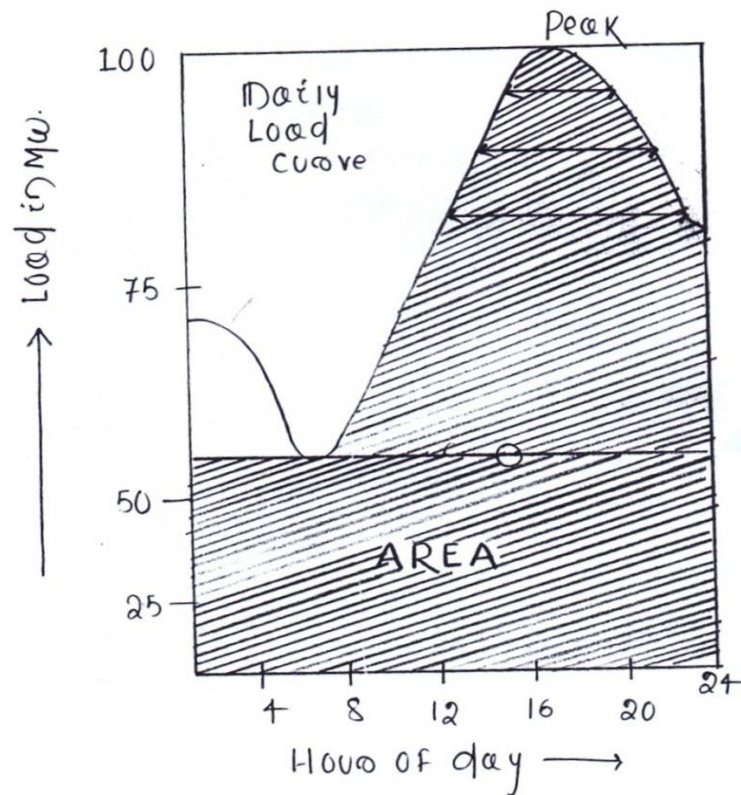

The following information can be obtained from daily load curve.

1. The variation of load during different hours of the day.
2. The area under daily load curve represents the total no of units generate in a day.
3. The peak of the curve represents. The maximum demand on the power station in a particular day.
4. The area under load curves divided by the total no. of hours represents the average load in a day for a power station.
5. The ratio of area under the load curve to the total area of the rectangle in which it is contained gives load factor.

Mathematically, load factor = mwh generate / mwhr which could have been generate

DEMAND FACTOR :

The ratio of the actual maximum demand on the system to the total rated load connected to the system called demand factor.

It is always less than unity.

Mathematically

Demand factor = maximum demand / connected loads

NOTES :

Generally maximum demand of a group of devices will be always less than the some of KW & KVA .

The minimum capacity of a generating plant must be such that it meets the maximum demand so, demand factor determines the capacity & the cost of power requirement to serve gain load.

MAXIMUM DEMAND :

The greatest of all short time interval averaged i.e. 15 minute, 30 min or 60min during a given period. (A day, a month, OR a year) on the power stations called maximum demand it is called system peak.

Note :

The maximum demand is not the greatest instantaneous maximum demand but it is the greatest short time average demand occurring during along period of time under consideration.

It determine size & cost of installation.

LOAD FACTOR :

The ratio of average load to the maximum demand during a certain period of time such as a day, or a month or a year.

Mathematically,

Load factor = average load / maximum demand

As, average load < Maximum demand so, load factor is always less than one. In other word load factor may be also defined as the ratio of no. of units actually generated in a given period to the no of units which could have been generated had the load or demand remain the maximum valve throughout this period.

Mathematically,

Load factor = units generated in a given period / maximum demand x No. of hrs operation in that given period.

DIVERSITY FACTOR :-

As the maximum demands of all the consumers supplied from an installations don't occur the same time. So the maximum demand is always less than some of individual maximum demands of all consumers connected to it. So the ratio of the individual maximum demand of all the consumer connected to it so, the ratio of the individual maximum demand of the power station.

Mathematically.

Diversity factor = sum of individual max^m demand / maximum demand on the power station.

[DIVERSITY FACTOR > 1]

CAPACITY FACTOR / PLANT FACTOR :

Every plant has to have a reserve capacity for the future explanation an increase in load. Therefore the total install capacity of the plant is usually greater than actually required (Maximum demand) so the capacity of the plant factor is defined as the average load to the rated capacity of the power plant i.e.

Capacity / plant factor = Average load / rated capacity of the power plant

In other word capacity factor may also be defined as the actual energy generated / maximum possible energy that the plant might have generated during a given period i.e.

Plant factor = units are generated in given period/(rated capacity of power plant X no. Of hrs in the given period)

= (units generated in a given period x maximum demand) / (max demand x rated capacity of power plant x no. of hrs in the given period)

= load factor x (max. demand /capacity factor)

Capacity of the plant daily energy produced maximum energy that could be produced daily. if the plant while running as per schedule were fully loaded.

BASE LOAD & PEAK LOAD ON POWER STATION

1. Base load :-

The unvarying load which occurs almost the whole day on the stations is known as base load.

2. Peak load :-

The various peak demands of load & above the base load of the station is known as peak load.

CHAPTER-9

TARIFF

Tariff means schedule of rates or charges. Tariff in case of Electricity supply is the schedule/rates frames or supply electrical energy to various classes of consumers.

Objective of tariff: The main objective is to distribute equitably the cost of supplying energy amount various classification of used. hence tariff consider the following items.

1. Recovery of cost of capital investment in generating transmitting & distributing equipment.
2. Recovery of cost of capital investment in generating transmitting & distributing equipment
3. Recovery cost of metering equipment billing, collection cost & miscellaneous services.
4. The satisfactory return on total capital investment.

Types of Tariff:

1. Flat rate tariff
2. Block rate tariff
3. Two – part tariff

Flat rate tariff: Generally this tariff is schedule by taking in to account load factor & diversity factor of each category of consumers. So in this tariff the different consumers are charged at different rate i.e. flat rate for light & fan load are slightly higher than that of power load. This method is most popular & easily under stood & simple calculation i.e. if energy consumed during billing period = x unit.

Flat rate = Rs. a/unit

Then charge = Rs. ax

Disadvantages

1. Separate meters are needed for different type of the supply.
2. Difficult to derive load factor & diversity factor for various types of load.

3. The consumers are charged for the total quantity of energy consumed at the same rate. Irrespective of magnitude of energy consumed. While increased generation or consumption spread the fixed charges for a greater number of units & so, the overall cost for unit decreases as the consumption increased.

BLOCK RATE TARIFF: The tariff in which block of energy is charged at higher rate & succeeding block of energy are charged at progressively reduce rate called block rate tariff.

Eg – 1st 25 units = Rs. 4.00 per unit

The next 40 units = Rs. 3.50 per unit

The consumption exceeding 65 unit = Rs. 3.00 per unit.

Advantages :

1. In this tariff consumer gets incentive for consuming more electrical energy which increases the load factor resulting reduction in generating cost.

Two part tariff / Hopkison demand :

In this tariff the total charges are splited into two component i.e. fixed charge & running charges.

Fixed charge : It is independent of energy consumed & proportional to the maximum demand i.e. it is made at a certain amount per kw of maximum demand & on the basis of the ratioable values. Of the premises or no. of room excluding bathroom or the connected load or the total combine kw capacity of all devices of consumers.

Running charge : It is made at a certain amount per kw for the total energy consumed.

Mathematically:

Total charges = Rs (a x kw+b x kwh)

Where a = Fixed charge per kw of the maximum demand

b= running charges per kwh of energy consumed.

The tariff is applicable in medium industry. Here, Fixed charge recover interest & depreciation on the capital cost building equipment taxes, insurance & operating cost which are independent of energy supplied varies with maximum demand while running charges recovers operating cost which varies with variation in energy consumption.

Disadvantage :

1. Unnecessary a consumer has to pay fixed charge without consumption.

Eg.- If company remains closed for a month but company Owner has to pay fixed charge mandatory.

Problem-1

Compute the cost of electrical energy for consuming 375 kw under block rated tariff quoted as follows.

1st 50kw at 4.00 per kwh

50kw at 3.60 per kwh

Next 50kw at 3.00 per kwh

Next 50 kw at 2.50 per kwh

Excess over 200 kwh at Rs. 2.10 per kwh.

a. Energy charge for 1st 50 kwh = Rs. 4.00x50 = Rs. 200.00

Energy charge for next 50 kwh = Rs. 3.60x50 = Rs.180.00

Energy charge for next 50 kwh = Rs. 3.00x50 = Rs. 150.00

Energy charge for next 50 kwh = Rs. 2.50x50 = Rs. 125.00

Energy charge for next rest 375.200 i.e. 175 kwh=

Rs. 2.10x175 = Rs. 367.50

Total cost of electrical energy for 375 kwh=

Rs. (200+180+150+125+367.50) = 1022.50

Average cost = 1022.50 / 375 = Rs. 2.72/kwh

Problem – 2

Daily load of an industry is 200 kw for 1st hrs, 150kw for next 7 hour, 50 kw for 8 hour & 1kw for the remaining time. If the tariff is force Rs. 1000 per kw of maximum demand per annum plus Rs. 2.25 per kwh find the electricity expenditure per year.

a. Daily energy consumption = $200 \times 1 + 150 \times 7 + 50 \times 8 + 1 \times 8 = 1658 \text{ kwh}$

Annual energy consumption = $1658 \times 365 = 605170 \text{ kwh}$

Demand charges per annum = $\text{Rs } 1000 \times 200 = 200,000,000$

Energy charges per annum = $2.25 \times 605170 = 1361632.50$

Total energy expenditure per annum = $200000 + 1361632.50$

$= \text{Rs. } 1561632.50$

SUB-STATION-10

POLE-MOUNTED SUB-STATION

It is a distribution sub-station placed overhead on a pole. It is the cheapest form of sub-station as it does not involve any building work. Fig (i) shows the layout of pole-mounted sub-station whereas Fig. (ii) shows the schematic connections. The transformer and other equipment are mounted on H-type pole (or 4-pole structure).

The 11 kV line is connected to the transformer (11kV / 400 V) through gang isolator and fuses. The lightning arresters are installed on the H.T. side to protect the sub-station from lightning strokes. The transformer steps down the voltage to 400V, 3-phase, 4-wire supply. The voltage between any two lines is 400V whereas the voltage between any line and neutral is 230V. The oil circuit breaker (O.C.B.) installed on the L.T. side automatically isolates the transformer from the consumers in the event of any fault. The pole-mounted

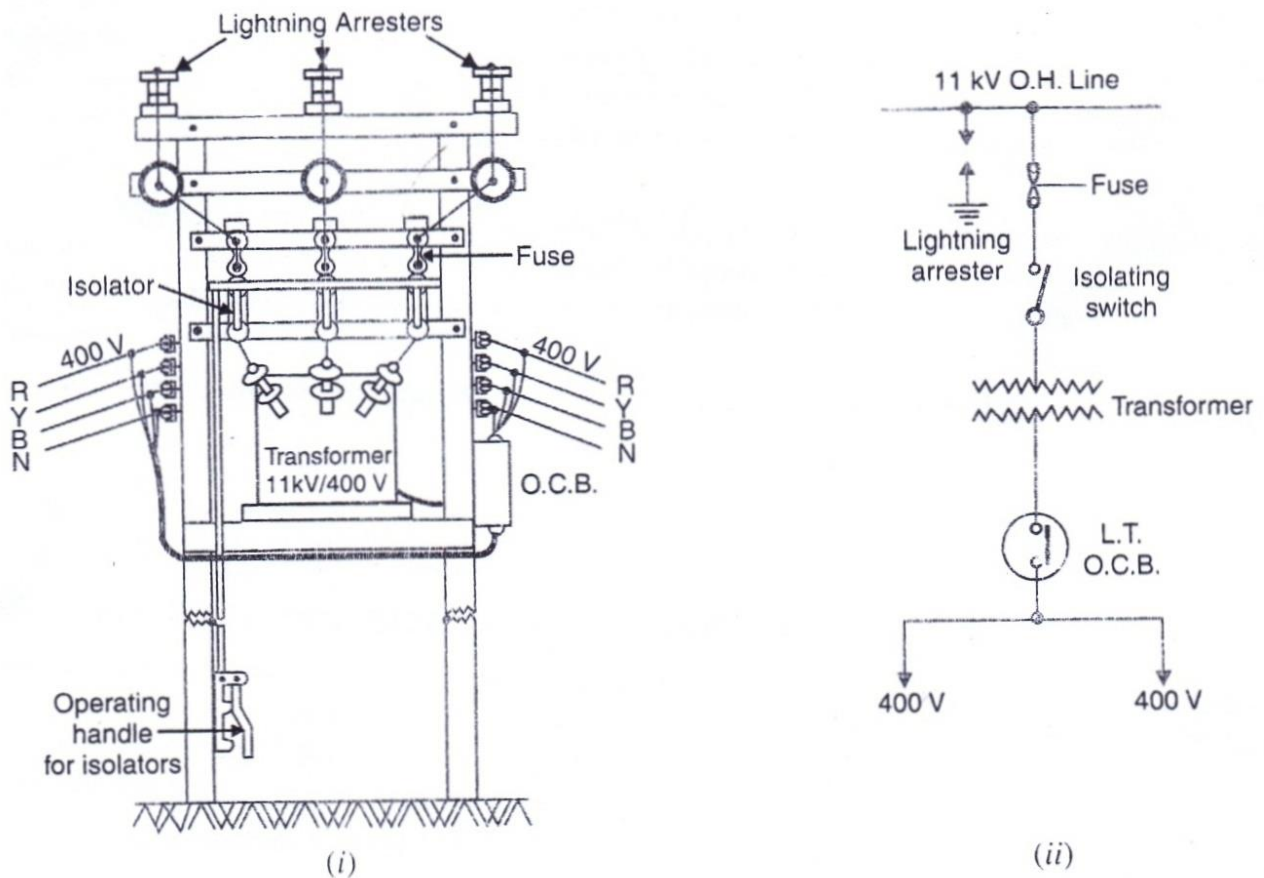

transformers can also be used. The use of 3-phase transformer (instead of 3 single phase bank of transformers) permits two advantages. Firstly, only one 3-phase load-tap changing mechanism can be used. Secondly, its installation is much simpler than the three single phase transformers.

The power transformer is generally installed upon lengths of rails fixed on concrete slabs having foundations 1 to 1.5 m deep. For ratings upto 10 MVA, naturally cooled oil immersed transformers are used. For higher ratings, the transformers are generally air blast cooled.

BUS-BAR ARRANGEMENTS IN SUB-STATIONS

Bus-bars are the important components in a sub-station. There are several bus-bar arrangements that can be used in a sub-station. The choice of a particular arrangement depends upon various factors such as system voltage, position of sub-station, degree of reliability, cost etc. The following are the important bus-bar arrangements used in sub-stations

- (i) **Single bus-bar system.** As the name suggests, it consists of a single bus-bar and all the incoming and outgoing lines are connected to it. The chief advantages of this type of arrangement are low initial cost, less maintenance and simple operation. However, the principal disadvantage of single bus-bar system is that if repair is to be done on the bus-bar or a fault occurs on the bus, there is a complete interruption of the supply. This arrangement is not used for voltages exceeding 33kV. The indoor 11 kV sub-stations often use single bus-bar arrangement.

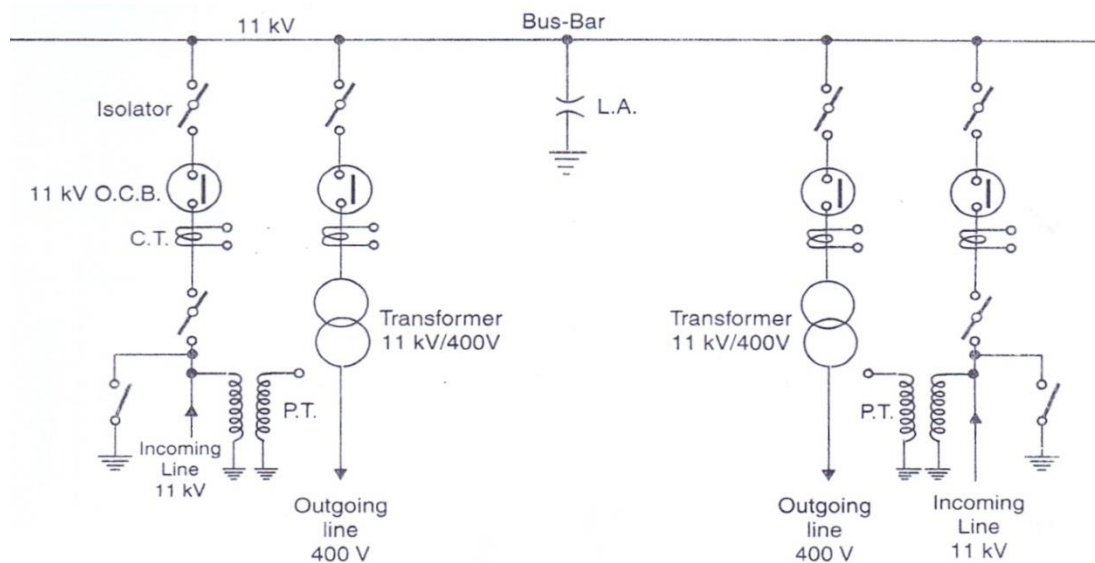
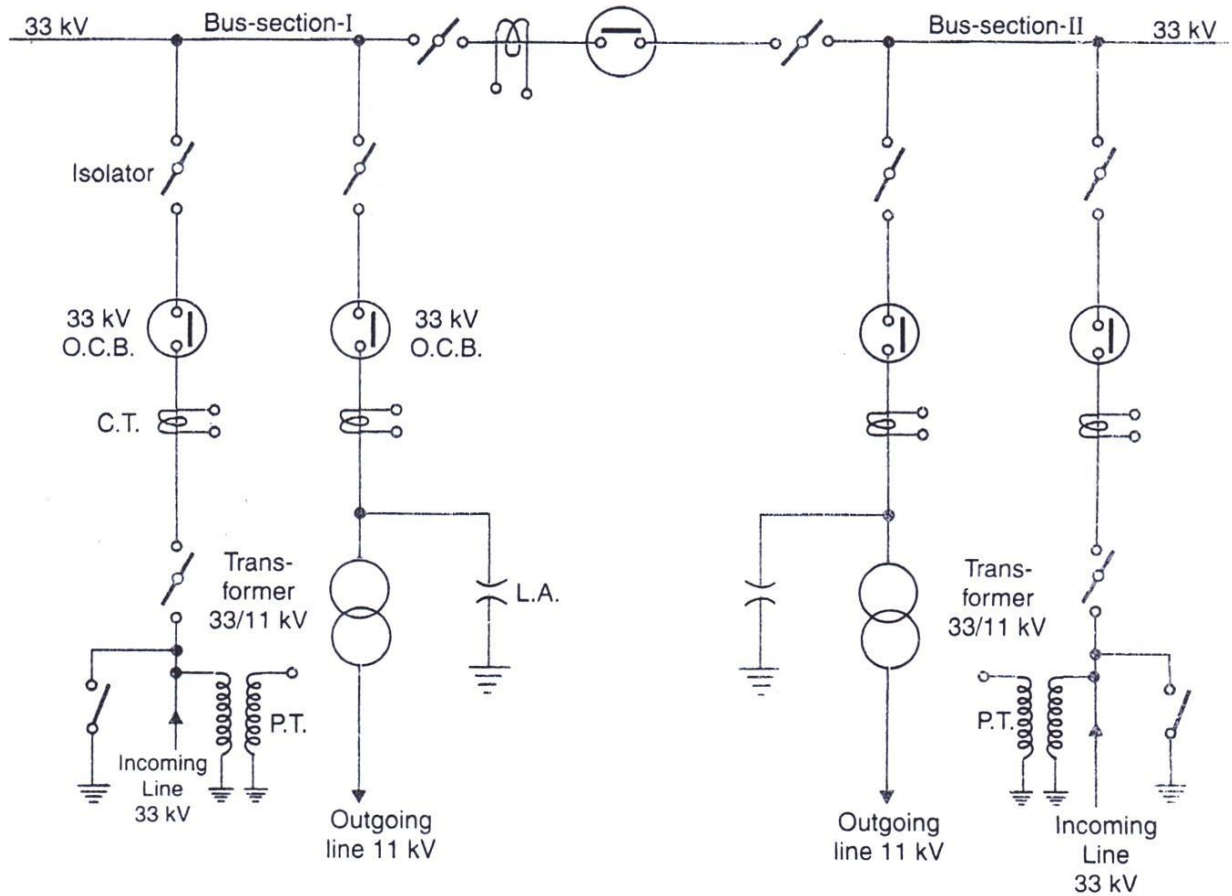
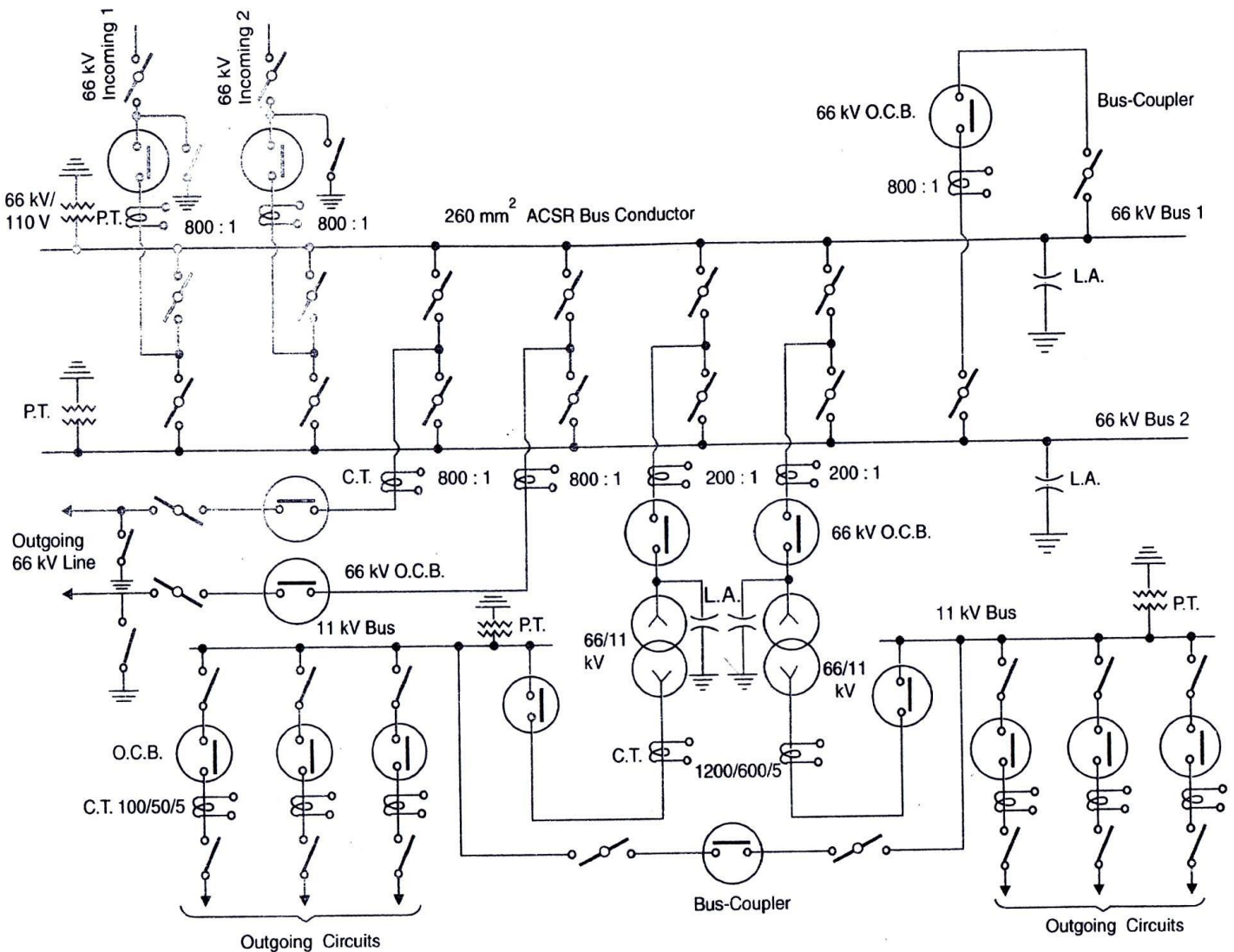

Fig-1

Fig-1 shows single bus-bar arrangement in a sub-station. There are two 11 kV incoming lines connected to the bus-bar through circuit breakers and isolators. The two 400V outgoing lines are connected to the bus bars through transformers (11 kV/400 V) and circuit breakers.





66KV SUB STATION

- (i) There are two 66 kV incoming lines marked 'incoming 1' and 'incoming 2' connected to the bus-bars. Such an arrangement of two incoming lines is called a double circuit. Each incoming line is capable of supplying the rated sub-station load. Both these lines can be loaded simultaneously to share the sub-station load or any one line can be called upon to meet the entire load. The double circuit arrangement increases the reliability of the system. In case there is a breakdown of one incoming line, the continuity of supply can be maintained by the other line.

- (ii) The sub-station has duplicate bus-bar system: one 'main bus-bar' and the other spare bus-bar. The incoming lines can be connected to either bus-bar with the help of a bus-coupler which consists of a circuit breaker and isolators. The advantage of double bus-bar system is that if repair is to be carried on one bus-bar, the supply need not be interrupted as the entire load can be transferred to the other bus.
- (iii) There is an arrangement in the sub-station by which the same 66 kV double circuit supply is going out i.e. 66 kV double circuit supply is passing through the sub-station. The outgoing 66 kV double circuit line can be made to act as incoming line.
- (iv) There is also an arrangement to step down the incoming 66 kV supply to 11 kV by two units of 3-phase transformers; each transformer supplying to a separate bus-bar. Generally, one transformer supplies the entire sub-station load while the other transformer acts as a standby unit. If need arises, both the transformers can be called upon to share the sub-station load. The 11 kV outgoing lines feed to the distribution sub-stations located near consumer's localities.
- (v) Both incoming and outgoing lines are connected through circuit breakers having isolators on their either end. Whenever repair is to be carried over the line towers, the line is first switched off and then earthed.
- (vi) The potential transformers (P.T.) and current transformers (C.T.) are suitably located for supply to metering and indicating instruments and relay circuits (not shown in the figure). The P.T. is connected right on the point where the line is terminated. The CTs are connected at the terminals of each circuit breaker.
- (vii) The lightning arresters are connected near the transformer terminals (on H.T. side) to protect them from lightning strokes.
- (viii) There are other auxiliary components in the sub-station such as capacitor bank for power factor improvement, earth connections, local supply connections, d.c. supply connections etc. However, these have been omitted in the key diagram for the sake of simplicity.