

LEARNING RESOURCE MATERIAL

ON

CIVIL ENGINEERING MATERIALS

UNDER EDUSAT PROGRAMME

SCTE&VT, BHUBANESWAR

ODISHA

Nodal Officer – Dr. M.R. Samal

Co ordinator – Sri M.R. Nayak

CONTENT

Chapter No.	Topic	Page No.	Prepared by
01	Stone		Dr. S.K. Nayak, Trg. Supdt, GP, BBSR
02	Bricks		-do-
03	Clay Products & refractory materials		Lalima Beura, Lect(Civil), IIT, Choudwar
04	Cement		-do-
05	Sand, gravel, morrum & fly ash		-do-
06	Mortar & concrete		Sri M.R. Nayak Sr. Lect(Civil), UCPEs, Berhampur
07	Timber		-do-
08	Paint, Varnish & distemper		Sri K.C. Das, Lect(Civil), OSME, Keonjhar
09	Iron & steel		-do-
10	Bituminous material		Sri P.K. Sahoo Lect(Civil),BOSE, Cuttack
11	Plastics, Heat proofing and Acoustics material		-do-

CHAPTER 1

STONES

1. INTRODUCTION

Naturally occurring compact, solid and massive material in the earth's crust or on the surface are known as rocks. Rocks don't have definite shape and chemical composition. They are mixture of two or more minerals. Stones are derived from rocks and are used as construction material.

Minerals are naturally occurring inorganic substance having definite atomic structure and chemical composition. Minerals are divided into two types.

1. Rock forming minerals
2. Ore minerals

2. CLASSIFICATION OF ROCKS

The rocks from which stones are derived are broadly classified into three types. They are:

1. Geological classification
2. Structural or Physical classification
3. Chemical classification

Geological classification:

The classification of rock based on the mode of formation or the process of formation is known as geological classification. According to this classification rocks/ stones are of three types.

1. Igneous rocks
2. Sedimentary rocks
3. Metamorphic rocks

Igneous rocks

Molten rock materials found below the earth's crust are known as magma. During volcanic eruption, this magma, under very temperature and pressure, and varieties of complex phenomena occurring below earth's crust beyond the comprehension of human being, comes

out to the surface. The rocks formed due to cooling and consolidation of molten magma on the surface is known as igneous rock. Not all the magma during a volcanic eruption comes out to the surface of earth.

Depending on the depth of the solidification of molten magma, igneous rocks are divided into three types.

1. Plutonic rocks
2. Volcanic rocks
3. Hypabyssal rocks

Plutonic rocks

The igneous rocks formed at a greater depth below the surface of earth are called plutonic rocks. These rocks are exposed on the surface due to erosion of overlying secondary rocks. These are coarsely crystallised. Examples of plutonic rocks are granite, syenite, gabbro.

Volcanic rocks

These are formed due to cooling and solidification of molten magma from numerous volcanic eruptions on the surface of earth. Examples of such rocks are basalt, trap and rhyolite.

Hypabyassal rocks

The rocks formed on account of cooling and solidification of molten magma at a shallower depth of about 2 to 3 km below the surface of earth. They show crystals that are partly coarse and partly fine. Examples of such rocks are aplites, dolerites, etc.

Igneous rocks are further divided into three types depending upon the silica content in them.

- a. Acid rocks
- b. Basic rocks
- c. Ultrabasic rocks

Acid rocks: in acid rocks amount of silica content is more than 66%. Examples: granite, rhyolite.

Basic rocks: Amount of silica content in these rocks is between 45 to 55%.

Ultra-basic rocks: Amount of silica content in these rocks is less than 45%.

Sedimentary rocks

The secondary rocks which are formed by chemical or mechanical activities of the weathering agents such as temperature, water, air, ice, etc. on the pre-existing rocks are known as sedimentary rocks. Weathering agents like wind, water, ice, atmospheric gases, etc. cause disintegration of the pre-existing rocks and thus sediments (particles) are formed. These sediments are transported and deposited by the agencies like river, seas, oceans, etc. The particles so deposited are gradually compressed and compacted under their own weight so as to form massive rocks. Rocks thus formed are known as sedimentary rocks. The process of formation of sedimentary rocks takes place for millions of years. Sedimentary rocks are also known as secondary rocks as they are formed due to weathering and erosion of primary rocks. These are also called stratified rocks because these rocks are formed in layers. Limestone and sandstone belong to this category of rocks.

Like igneous rocks, sedimentary rocks are formed in different ways. On the basis of the formation, sedimentary rocks are divided into three different categories.

- a. Clastic rocks
- b. Chemically formed sedimentary rocks
- c. Organically formed sedimentary rocks

Clastic rocks

The sedimentary rocks formed by deposition and consolidation of disintegrated sediments and fragments from previously formed rocks. These are formed in river basins, lake basins and sea basins. These types of stones are most widespread. They include sandstones, shales, breccias and conglomerates. Sandstones are very suitable as building stones.

Chemically formed sedimentary rocks

Many sedimentary rocks are precipitated from river, lake and especially from sea water by evaporation. Some of the components of the previous rocks are taken in solution during the process of weathering and erosion. The waters may get saturated with these compounds with passage of time and precipitate them. The huge accumulation of these precipitates evaporates ultimately may form rock deposits of considerable importance. Limestones, gypsum,

anhydrite and rock salts are few examples of chemically formed sedimentary rocks. These are not used as building stone.

Organically formed sedimentary rocks

A great variety of life exists in the water bodies such as seas and oceans. Many sea animals have their hard parts made of bones which are a mixture of calcium and magnesium carbonates. After the death of these marine animals, the dead parts accumulate on the sea beds. Gradually huge thickness of such deposits gets formed and compacted and consolidated with passage of time. These are the organically formed sedimentary rocks. Limestone is an example of this rock.

Metamorphic rocks

Igneous rocks and sedimentary rocks undergo structural change under the influence of high temperature, pressure and chemical action and thus the original character of the parent rock are partly or wholly changes. Such process is known as metamorphosis and the rocks so formed are known as metamorphic rocks. Examples: marble, slate, gneiss, etc. Marble is formed from limestone (CaCO_3) by gradual heating over a very large period of time.

Chemical Classification

On the basis of dominant chemical composition, three main types of rocks are:

- a. Silicious rocks
- b. Calcareous rock
- c. Argillaceous rocks

Silicious rocks

Silica is the predominant constituent of this rock and is more than 50% of the bulk composition of the rock. Some sedimentary and metamorphic rocks are entirely made of silica. These rocks are very strong and hence may be treated as good building stones. Examples of these rocks are granite, sandstone, gneiss.

Calcareous rocks

In these rocks carbonate is the dominant chemical component. These rocks generally belong to sedimentary and metamorphic rocks. Limestone, dolomite and marbles are entirely carbonate rocks and are very good building stones.

Argillaceous rocks

In these rocks clay (hydrous alumina silicate of K, Na, Ca and Mg) is the dominant component. These are mostly sedimentary and metamorphic rocks. These are very soft and hence not recommended as building stones. Examples of these rocks are slates and schists.

Structural Classification

On the basis of physical characteristics of the rocks, the manner and arrangement of different particles rocks are classified into three categories. They are:

1. Stratified
2. Unstratified
3. Foliated

Unstratified Rocks

These rocks occur in huge masses without showing any layered structure in them. Igneous rocks and many metamorphic rocks are unstratified in nature. Some of the sedimentary rocks may be of unstratified in nature.

Stratified Rocks

These rocks occur in distinct layers of same or different colour and composition. Most of the sedimentary rocks are stratified rocks. The different layers are called beds and separated by planes, called bedding planes. These bedding planes are the planes of weakness and thus play an important role in deciding the structural behaviour of the rocks as building material.

Foliated rocks

Some rocks have in them profuse development of well defined bands of different composition. Such rocks are known as foliated rocks. Examples of such rocks are schists and

gneiss. Sometimes such layers are induced under pressure. These are not very good building stones.

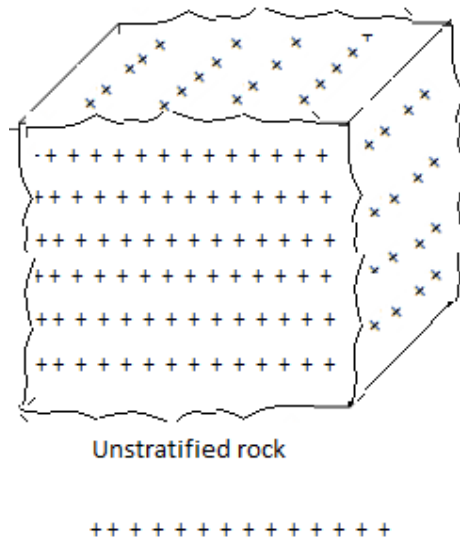

3. USES OF STONES

Stones on account of numerous advantages they have in terms of their strength characteristics, durability and bountiful availability as a natural resource have a wide spectrum of application including their use as very good and construction material for numerous civil engineering structures. Some of their uses are enlisted below.

- a. Stone is used for general building work , i.e., walls, foundations and superstructure.
- b. It is also used for heavy engineering works such as docks, bridges, light houses and harbours.
- c. It is used in industrial constructions.
- d. It is used road metal and railway ballast.
- e. It is used as raw material for manufacture of lime.
- f. It is also used as flux steel plant in the manufacture of iron.

4. NATURAL BED OF STONE

The plane of contact (junction) of two layers of rocks in a stone obtained from stratified rock is known as the natural bed. It is also known as plane of cleavage or weakness.

The strength and durability of stratified stone depend on its position in a structure i.e., if the load is perpendicular or parallel to the bedding plane of the stone. The compressive strength of stone with the load acting perpendicular to the direction of 'natural bed of the stone' or plane of cleavage is always greater than that when the load acts parallel to the bedding plane.

In case of walls and columns where the load acts vertically downwards, the stones should be placed with natural bed horizontal so that thrusts act normal to the bedding plane. In arches where the load acts transverse, the stones are placed with natural bed vertical or inclined so that it is almost normal to the resultant forces.

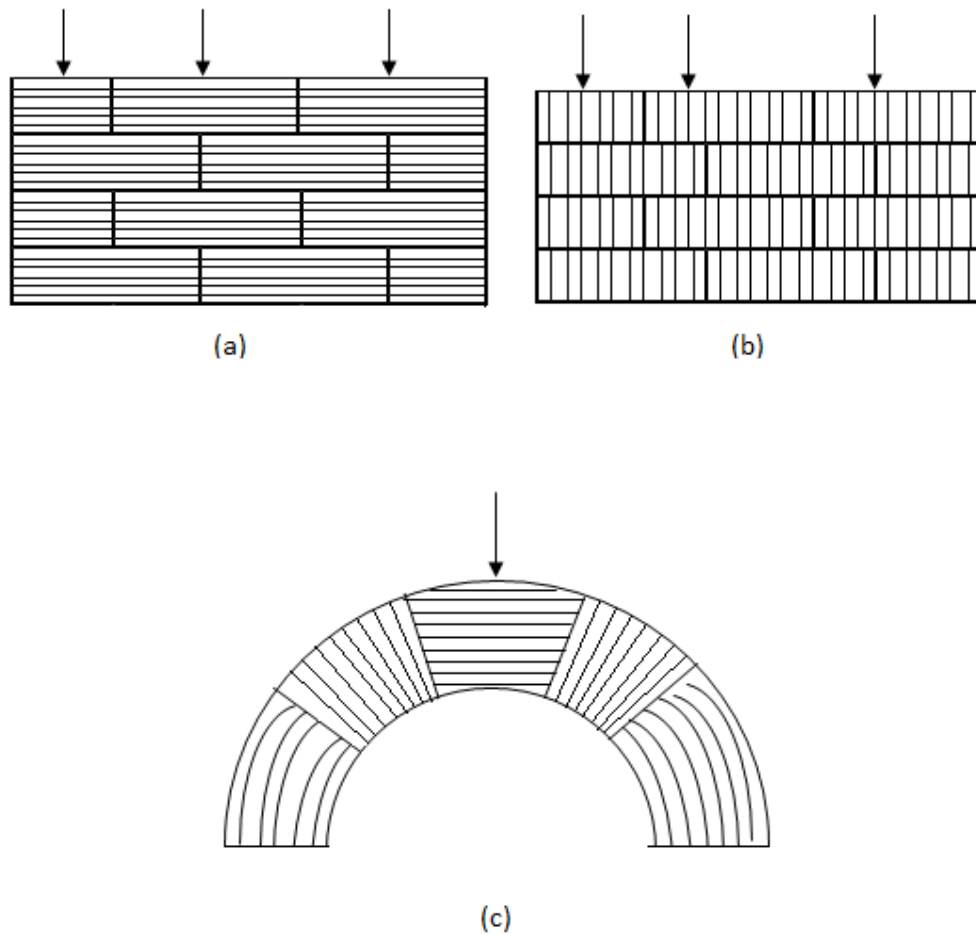

Figure 1.2 Forces with respect to natural bed

5. QUALITIES OF GOOD BUILDING STONE

Stones have wider applications in construction of heavy structures such as buildings, dams, harbours, weirs, bridges, etc. The qualities and suitability of good building stones should have the following characteristics with the attributes given in each of them.

1. Appearance

The stones should be of uniform and appealing colour. Lighter colours are preferred to darker ones as darker ones are less durable. For face work, the appearance of the stones very important.

2. Strength

Stones used for building construction are subjected to compressive load. So the stones should have high value of compressive strength to withstand the compression without getting crushed. closed grain and uniform textured stones are generally good in compressive strength.

3. Structure

A good stone if broken should not give dull appearance. Closed grain and crystalline structured stones are good building stones. Good building stone should have uniform texture. They should be free from cavities and cracks.

4. Hardness

A good stone should be hard enough to resist the abrasion due to friction. Generally the stones used in floors, pavements and aprons of bridge should have greater value of hardness. Hard stones should show no sign of scratching if scratched by knife.

5. Toughness

Good stones should also be tough to withstand the vibration machineries and vibration due to moving loads over them. Stones used in construction of roads should be hard and tough.

6. Heaviness

Specific gravity is the measure of heaviness of a substance. The specific gravity of a good building stone should be between 2.4 to 2.8.

7. Durability

A good building stone should be long lasting. They should resist the action of weathering agents such as wind, rain, ice and temperature. Durability of stones depend upon their chemical composition and physical structure. A compact, homogeneous and free from chemicals susceptible to the action of hydrochloric acid and sulphuric acid.

8. Porosity and water absorption

Porosity is the percentage of void spaces available in a given volume of stone. Good building stone should have less water absorption. The water absorption of good building stone should be less than 5%.

9. Resistance to fire

Stone when exposed to fire should be able to resist temperature. The stones should be free from minerals such as CaCO_3 and iron oxide which likely to decompose on heating. Quartz expands on low temperature. Hence stones should not be composed of minerals of different coefficient of thermal expansion.

10. Dressing

Stones should possess good dressing properties for carving. Marble is a good example of stone which has good dressing properties. However stones having good dressing qualities are weak in strength, less durable. Their hardness is also low.

11. Seasoning

Stones after quarrying and dressing should be left for a period of 6 to 12 months for seasoning before used for construction. A well seasoned stone is free from quarry sap.

6. STONE QUARRYING

The process of extraction of suitable stones from their natural place of occurrence is called quarrying. Quarrying is also known as open cast mining for extraction of stones from natural rock. However, quarrying is different from mining in the way that in various operations are

carried out for exploration and extraction of minerals such as coal, quartzite, etc., from a mine under the earth.

There are different methods employed for quarrying of stones depending upon the geological structure of rock, amount of material required and their availability. They are:

- a. Quarrying without blasting (Quarrying by hand tools such as crowbars, jumpers, pickaxe, feathers and wedges, channellizers, etc.
- b. Quarrying by blasting

Quarrying by hand tools

The rocks in the earth's crust are accompanied by the bedding planes, joints, fissures and cracks, etc. these offer least resistance for to splitting. In these methods light hand tools or even light channelling machines called channellizers are used for removal of block of rocks. In these methods no explosive material is used for breaking the stone. Some of the methods of quarrying by hand tools are:

1. Digging

This method is used to quarry small pieces of stones. They are broken by pick-axe and taken out by crowbar. Laterite stones are quarried by digging.

2. Splitting

Splitting method is used for obtaining large blocks from hard and tough rock. Large blocks can be split by heating to get rectangular pieces. Wood, leaves or any other form of fuels is burnt on the surface of stone for few hours. Due to unequal expansion, stone splits and upper layer is separated. Separated stone pieces are taken out and given the desired shape for use.

3. Wedging

In this method a few holes are dug at selected places on the rock surface by using chisels and hammers or hammer drills. Steel wedges are inserted into each holes between two steel strips called feathers. The inserted wedges are struck simultaneously with hammers. As a result of hammer blows, cracks appear along the lines joining the holes. Then long iron bars are

inserted into the holes and the cracks so caused help removing the block of rocks. Quarrying by wedging is shown in the Figure 1.3.

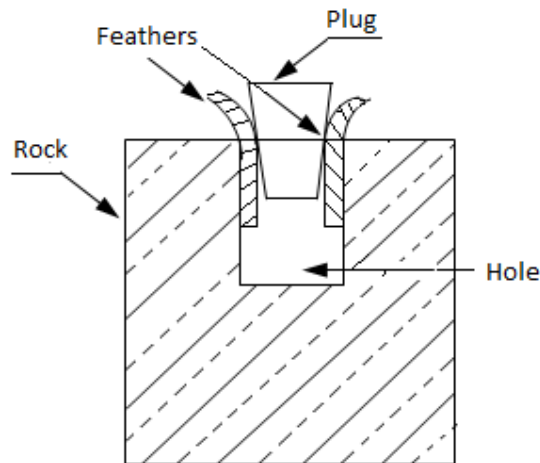

Figure 1.3 Plug and Feathers

4. Channelling

In this method big machines called channellizers are used for quarrying. the machines are power driven. Channellizers are used for cutting large size single block of costly stones like marbles and lime stones. The channellizers can cut a groove up to 3 m depth, 3 m length and 5 m width. Holes are then drilled horizontally from the free side to meet the groove at the back at its base. Wedges and steel bars are used to remove the block(B) from the rock. Figure 1.4 shows quarrying by channelling.

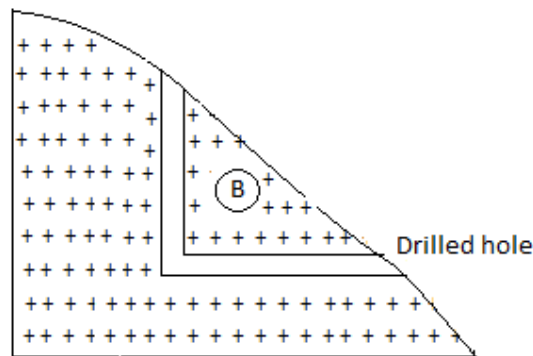

Figure 1.4 Quarrying by channelling

7. DRESSING

The process of giving proper size, shape and finish to the stone obtained from the quarry is known as dressing. Dressing is done either by manually or mechanically or both.

Objective of Dressing

- a. To reduce the size of the blocks to potable units: Dressing reduces the size of the block and hence the weight. Reduction of weight decreases the cost of transportation of stones from the quarry site.
- b. To give proper shape to the stone: Different structural units require stones of different shape. Hence, stones are to be dressed before use as structural units.
- c. To give appealing finish: Stones used in exposed face of the walls in temples and monuments should be dressed to give aesthetic appearance.

Methods of Dressing

There are different methods of dressing. Some manual methods of dressing are as follows.

Pitched face dressing

In this method, only the edges of a block of stone are made level with skilful use of hammer. The surface is left in original cut. The minimum width of pitched face dressing round the four edges of the face shall be 2.5 cm.

Hammer dressing

In this dressing, the edges as well as faces are dressed to give an even regular surfaces. A hammer dressed stone is given rough tooling for a minimum width of 2.5 cm along the four edges of the face of the stone.

Chisel drafting

In this method, straight grooves are made with the help of chisel at all the four edges. The superfluous stone at the centre is removed by chisels. The stones so dressed are used in plinths and corners of the buildings.

Rough tooling

In this method, a series of bands 4 to 5 cm wide with grooves in between are made all over the surface. Each band has tool marks in them. these tool marks may be horizontal, vertical or at an angle of 45° etc. The edges and the corners are made square by using chisel and hammer.

Punched dressing

Punched dressing is done on the stones that have already been rough-tooled. In this method a series of parallel ridges are made by using hammer and chisel. These stones are used at places where even surfaces are required.

Close picked fine tooling

In this type of dressing, almost every type of irregular projection is removed from all the four sides of a stone. Its surface is given fine finish and appealing look.

Polishing

Polishing of stones is done by rubbing with suitable abrasive material. Polishing of stone may be done by holding them firmly on the top of a revolving table to which some abrasive material like sand or carborandum are fed.

8. CHARACTERISTICS OF DIFFERENT TYPES OF STONES AND THEIR USES

Granite: It is a coarse to medium grained igneous rock. It is essentially made up of felspar, quartz and mica.

Characteristics

- a. Its specific gravity is 2.64 and water absorption is less than 1%.
- b. It has mottled (spotted) appearance.
- c. Most granites excellent building properties and are significantly strong and durable. Crushing strength varies from 110 to 140 MN/m².
- d. Granites have poor fire resistance and crack under strong fire.
- e. Granites have the capacity to take very fine and glassy polish.
- f. Quantity of felspar decides the colour of granite.

Uses

- a. Fine grained granite is suitable for ornamental column, plinth, etc. as it takes very fine polish and exhibits glassy appearance.
- b. High values of strength, hardness, specific gravity and durability make it suitable for construction of sea walls, light houses and bridge piers, etc.
- c. Large pieces are used as building blocks for masonry structures, smaller ones as road metals or railway ballast and the chippings for manufacture of concrete.

Basalt: It is a volcanic type igneous rock. The main constituents are silica, alumina and felspar.

Characteristics

- a. Its specific gravity is about 2.96.
- b. It is very heavy and strong and is heavier than granite.
- c. Its crushing strength varies from 70 to 80 MN/m².
- d. It has greenish grey to dark grey colour.

Uses

- a. Basalt is suitable for paving sets and as a road metal.
- b. It is used as aggregate in concrete.
- c. It is also used for manufacture of artificial stones.

Limestone: Limestone is a sedimentary rock of calcareous variety and of organic origin. In its purest form, it contains mainly CaCO₃, although some varieties may contain MgCO₃ and small amount of silica and alumina.

Characteristics

- a. Its specific gravity is 2.6.
- b. Its crushing strength is about 52 MN/m².

- c. The colour of limestone depends on its composition, especially the type of finely dispersed impurities present throughout the carbonate matrix. However, they are available in three main colours viz., brown, yellow and dark grey colours.

Uses

- a. Limestones are not very useful as building stone because of their poor strength values. However, dense, compact and massive varieties are used for stone masonry in walls.
- b. It is used as road metal when better materials like basalt and granite are not available.
- c. It is used in blast furnaces, bleaching, tanning and other industries.

Marble: It is metamorphic rock of calcareous variety. It is formed from the metamorphosis of limestone. Its main constituent is recrystallised hard and compact CaCO_3 .

Characteristics

- a. Its specific gravity is about 2.72.
- b. Crushing strength of marble varies from 50 to 60 MN/m^2 .
- c. It is very hard and takes a fine polish.
- d. It is available in a variety of colours such as white, yellow, grey, green, red, blue and black colours.
- e. It is easy to work with marble.

Uses

- a. It is for carving and decoration work.
- b. It is also used for steps, wall linings, columns, electrical switch boards and table tops.

Sandstone: It is a sedimentary rock of siliceous variety. It contains sand or quartz cemented by lime, mica, magnesium, alumina, iron oxide.

Characteristics

- a. Its specific gravity is 2.25.

- b. Its structure shows sandy grains.
- c. Crushing strength of sandstone varies from 35 to 40 MN/m².
- d. Sandstones occur in many colours viz., white, grey, pink, red, maroon and dark.
- e. Fine grained sandstones with siliceous cementing material are strong and durable and are excellent building materials.
- f. Sandstones of different hues are available e.g., white, grey, brown, pink, etc.

Slate: It is a metamorphic rock of argillaceous variety. It has a distinct foliated structure. It is composed of alumina mixed with sand or carbonate of lime.

Characteristics

- a. Its specific gravity is 2.8.
- b. A good slate is hard, tough and fine grained.
- c. Crushing strength of slate varies from 60 to 70 MN/m².
- d. It has grey or dark blue colour.
- e. It can be split into thin sheets.
- f. It is non-absorbent and durable.
- g. It produces a sharp metallic sound on hammering.

Uses

- a. Thin-layered slates having good compressive strength are used as sills and for pavements inside and outside palatial building.
- b. Slate is practically impervious and hence very suitable for roofing stone and urinal partitions.

Laterite: It is sedimentary rock composed mostly of oxides of aluminium with varying amounts of oxides of iron.

Characteristics

Its specific gravity varies from 2 to 2.2.

It has a poor compressive strength, which varies from 20 to 30 MN/m².

It is light to dark red in colour.

It has a porous and spongy or cellular structure.

Uses

- a. Laterite is used as a building material only in ordinary construction.
- b. It is mostly used as road metals.

Gneiss: It is a metamorphic rock. It is formed by the metamorphosis of granite and has the same constituents as granite. It is siliceous in composition and foliated in structure.

Characteristics

- a. Gneisses are coarsely crystalline rocks.
- b. It can be freely split into slabs.
- c. Gneiss is more easy to work with than granite.
- d. It is available in different colours.

Uses

- a. Coarsely crystalline and uniformly textured gneisses are as good building materials as granites.
- b. It is used for ornamental and decorative purpose.

Quartzite: It is composed of silica. It is dense, hard and glassy in structure. Some varieties of quartzite are very hard and strong and are considered to be very good as building stone. It is strong and durable and used as road metal or railway ballast. It is also used in concrete.

CHAPTER 2

BRICKS

I. DEFINITION

Bricks are structural units of rectangular shape and convenient size, and are made of suitable clay by the process of moulding, drying and burning.

Since long, bricks are believed to have been used by the people of ancient civilization. This has been established beyond doubt from the excavation of prehistoric sites like Indus Valley civilization at Mohen-jo-daro and Harrappa. Bricks are the most favoured structural units used for construction in the modern day world around the globe. This is on account of the following reasons in favour of bricks.

1. Easy availability of clay
2. Knowhow of construction methods
3. Ready-to-use size, shape and handling
4. Cost

All the above factors combined together go in favour of bricks to make them a very convenient building material.

II. COMPOSITION AND SELECTION OF BRICK EARTH

Earths of specific characteristics are used for manufacturing good bricks. A good brick earth should have the following components to give desired characteristics to the bricks manufactured from them. A suitable brick earth should have the following composition in the desired proportion.

Alumina

A good brick earth should have 20 to 30% of alumina. It gives required plasticity to the brick earth in the moulding stage (wet condition). Alumina content in brick earth should not be more than 30% because it makes the earth more plastic. Bricks made of such earth shrink on drying and cracks may appear on moulded bricks. However, if percentage of alumina is less than 20%, moulding of bricks to proper shape would become difficult.

Silica

The percentage of silica in good brick earth should be 50 to 60. Silica in brick earth may be present as a constituent of clay minerals or as free silica in the form of sand or quartz. Desired percentage of silica in clay imparts hardness and strength to the brick. Silica gives resistance against shrinkage and durability of brick to weather. However, if percentage of silica are higher in silica, moulding becomes difficult. Such bricks are found to be quite brittle and porous.

Iron Oxide

A small amount of iron oxide (4 to 6%) reduces the softening temperature and makes the fusion of various constituents of clay possible at lower temperature. It also gives characteristic red colour to the bricks. However, excess of iron oxide makes the brick too soft during burning which causes deformation of shape and size of the brick. The colour also becomes darker and hence not appealing.

Lime

Presence of lime makes burning and hardening quicker. Lime, if any, should be present in finely powdered form and thoroughly dispersed. Slaking or disintegration may take place due to presence of lime in the form of nodules or lumps.

Undesirable or harmful components

The brick earth should ideally free from the following harmful components.

1. Lime nodules
2. Organic matter and vegetable roots
3. Sulphides and sulphates
4. Alkali salts
5. Pebbles of stone and gravel

III. BRICK MAKING

Brick making or brick manufacturing involves the following steps.

1. Preparation of brick earth

2. Moulding of bricks
3. Drying of bricks
4. Burning of bricks

1. Preparation of brick earth

The site with soil suitable for manufacture of bricks is selected. After selection of site, the top 15 to 20 cm layer overburden is removed to clear off harmful undesirable ingredients such as vegetation, pebbles and other organic matter. The earth below is then dug out and spread on the ground and exposed to the atmosphere for a period of about two weeks. Sometimes, additional amount of sand, lime etc. are also mixed with the dug soil depending upon the requirement if any. This process is known as **weathering**.

After weathering, the earth is then ground thoroughly to break the lumps if any present in it. The weathered earth is thoroughly mixed with the sand, lime added to it. The process is known as **blending**.

The blended earth is then spread out on a platform and desired amount of water is added to the mixture and the mixture is then **kneaded** thoroughly so as to form a homogeneous and plastic mix. This process is known as tempering. Generally 25 to 30% of water is sufficient to make the mixture plastic enough for moulding. The amount of water added depends on the type of moulding.

For large scale manufacture of bricks, **pug mill** is used for kneading of clay. It consists of a conical upright steel cylinder covered at the top and with a hole at the bottom. Figure 2.1 shows a typical pug mill. It is 2 to 3 m in height, a part of which is buried under the ground. The top diameter is slightly more than the bottom diameter. A central rotating vertical shaft pivoted at the base, which can be rotated with the help of long arm driven mechanically or manually. The central shaft is attached with horizontal blades carrying knives.

Seasoned clay and water are added from the opening at the top. The rotation of the shaft and its churning effect on the clay-water mixture produce mud of required plasticity. The mud is then taken out from the hole at the base for moulding.

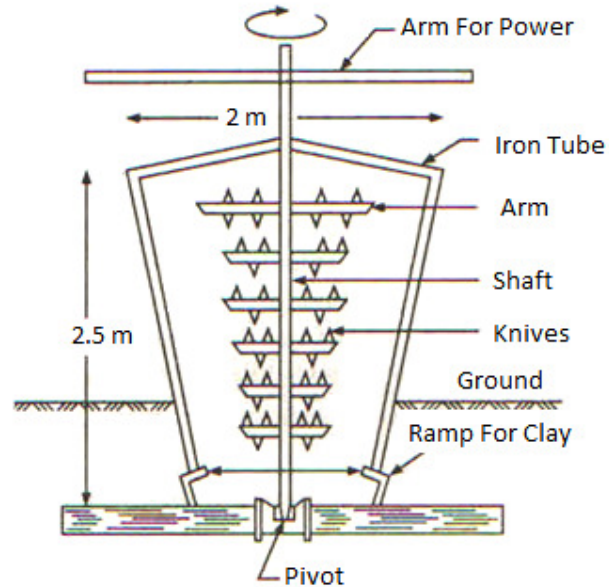

Figure 2.1 Pug Mill

2. Preparation of brick earth

The process of making green bricks of proper shape and size from the tempered clay is known as moulding. Moulding of brick is carried out with the help of a mould. A mould is made of either wood or steel. A wooden mould is fitted with iron plates at edges to make it strong. The inside dimensions of a mould are generally 8 to 10% larger than the size of the bricks. This is to allow shrinkage of bricks during drying.

There are two methods of moulding the bricks.

- a. Hand moulding
- b. Machine moulding

The tools essential in hand moulding process include brick mould, cutting edge or wire, wooden plates and stock board (Figure 2.2).

a. Hand moulding

In this method, moulding of bricks from tempered clay is done by using skilled manpower. The clay is invariably kept soft so that it can be given desired shape. The water content of the mud is generally 18 to 25% than those used for machine moulding. This method is further

divided into two types depending on the fact that whether the moulding is done on the ground or on a specially designed table. They are

- i. Ground moulding
- ii. Table moulding

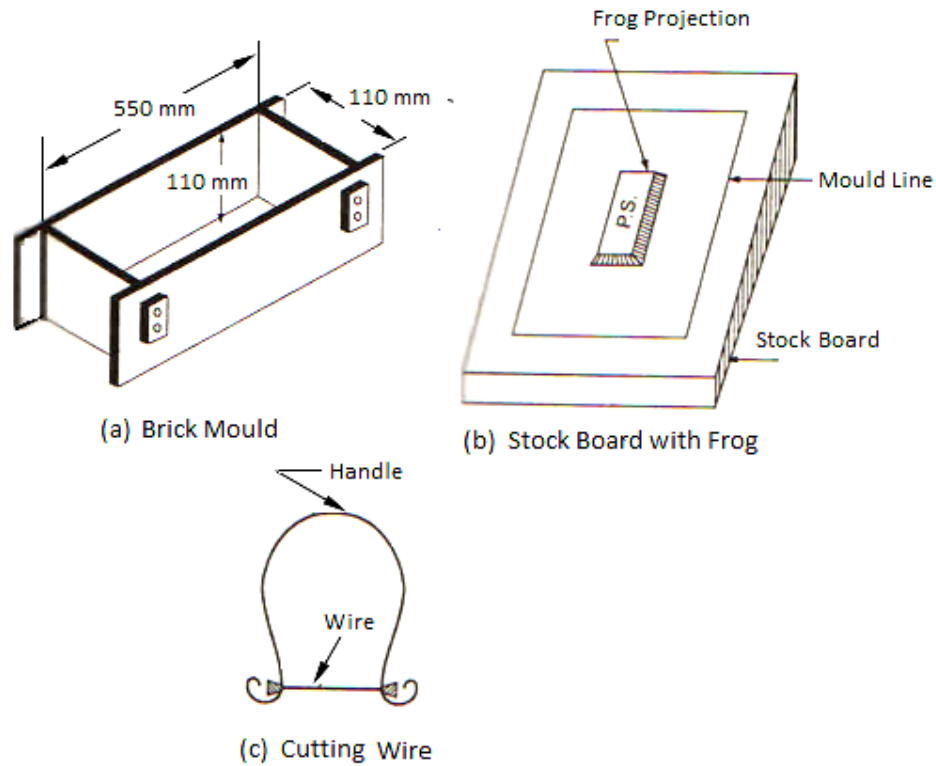

Figure 2.2 Tools in Hand Moulding

i. Ground moulding

The process of moulding bricks on the ground by skilled manpower is known as ground moulding. In ground moulding, moulding is done on a levelled and rammed ground. Sand is sprinkled over the ground to avoid the sticking of moulded brick with the ground. The moulding process is started from one end of the ground and continued to the other end. The moulded bricks are laid on the levelled ground for drying.

Ground moulding is carried out in the following steps.

The mould is dipped in water or sprinkled with sand in order to avoid sticking of the green mud to the inner side of the mould. A lump of is carefully dashed into the mould by hand. It should be ensured that the clay reaches to the sides and corners of the mould. Surplus mud if any is removed with the help of strike or cutting edge. The mould is then lifted with a sudden jerk leaving behind the moulded brick on the ground sprinkled with sand.

ii. **Table moulding**

In this process all the moulding operations are carried out by skilled worker on a specially designed table as shown in the Figure 2.3. The moulded bricks are transported to the drying place with the help of pallet boards. This process is similar to the pallet moulding on the ground. The mould is place over the stock board and some sand is sprinkled on the inside surface of the mould. A lump of mud is then carefully pushed into the mould, pressed thoroughly and skilfully such that the mud reaches to the side s and corners of the mould. The surplus mud is then cut away with the strike or cutting edge. A pallet is placed over the mould and the moulded brick is transferred to the pallet by turning the mould over it. The brick is transported to the drying yard.

Good quality bricks are produced in table moulding. However, the operation process is slow and hence the cost of production is slightly higher in table moulding. The table is large enough to accommodate all the accessories required for moulding.

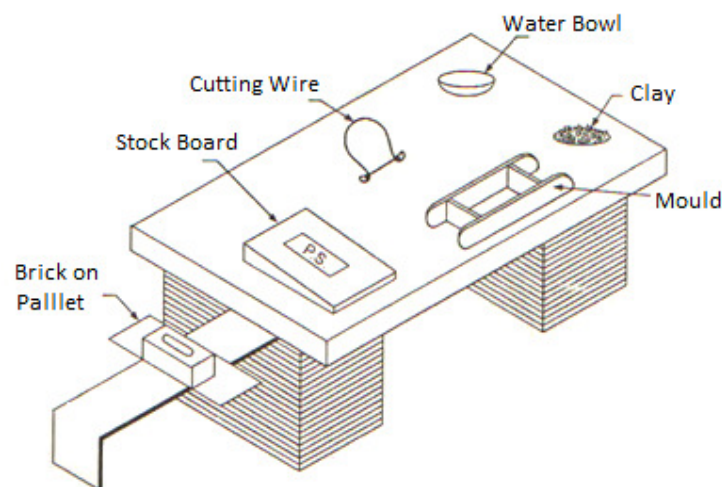

Figure 2.3 Table Moulding

b. Machine moulding

Machine moulding is useful for large scale manufacturing of bricks. About 2000 bricks can be moulded by a machine per day. It gives bricks of uniform quality and is cheaper in the long run. Depending on the water content of clay, two methods of machine moulding are in use.

- i. Stiff mud process
- ii. Dry process

i. Stiff mud process

In this method, the very stiff or plastic clay is used for moulding. Only a small quantity i.e., about 8 to 12% of water is added during tempering in the pug mill. The clay is made to pass under pressure through a moulding machine. The pressed mud comes out through the orifice which gives the mud a continuous ribbon shape of given height and depth. This is cut into desired length by means of cutting wires. The cut bricks are then taken away for drying. A brief description of a typical worm gear type moulding machine as shown in Figure 2.4 is give below.

Worm Gear Type Moulding Machine

A worm gear type moulding machine comprises of the following parts

- i. Feeding chamber provided with worm gear to apply pressure
- ii. Hopper to receive clay mix from pug mill
- iii. Fixed orifice provided in the narrow front end
- iv. Conveyor belt on set of rollers
- v. Cutting wire device adjusted in front of the orifice to cut the moulded brick to give it third dimension

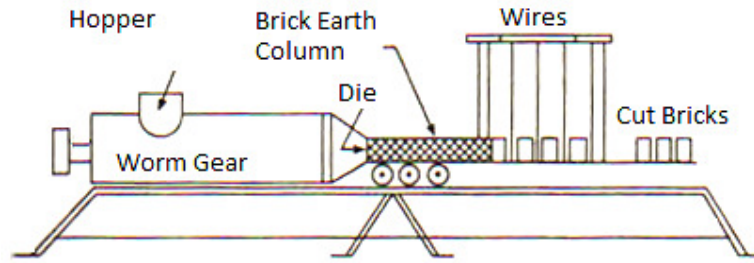

Figure 2.5 Worm Gear Type Machine Moulding

ii. Dry process

In this type of moulding, very small quantity of water, a maximum of 10% of water is added during tempering so that the mix is almost dry. The clay is then fed through the hoppers into the mould and is compressed by a plunger with a pressure of about 50-150 kg/cm². Such a pressure is sufficient enough to convert the loose damp clay mass into a dense, very compact brick unit, which is then removed from the mould. The metal mould is heated during the moulding process to avoid sticking of clay. Bricks from such moulding machines can be directly taken for burning. The bricks, thus manufactured, have perfect shapes and sizes.

3. Drying

Moulded bricks need to be dried before burning. Drying is essential due to following reasons.

- i. to make the green brick strong enough so that they can be handled during stacking
- ii. to allow loss of moisture content at a slow rate because if the bricks are straight away burnt, they may disintegrate due to rapid loss of moisture
- iii. the fuel requirement is significantly reduced with reduction of moisture content

There are two methods of drying

- a. Natural drying
- b. Artificial drying

a. Natural drying

In this method, bricks are dried in the sun in open after moulding. Bricks are laid flat side wise for 2 to 3 days for drying. When the bricks are dry enough to be handled safely, they are carried to the specially prepared drying yards for stacking. Drying yards are situated at a

higher elevation for draining off rain water. The bricks are stacked in the drying yards by keeping them at their edges. 8-10 bricks are kept in each row of a stack. Enough space is left between the rows and the layers in a stack for free circulation of air around each brick. Bricks are protected from direct exposure to sun. And sometimes roofs are also made over drying yard to protect them from heavy rains. **Figure ddd** shows a typical stack.

b. Artificial drying

Artificial method of drying is used in mechanized brick manufacturing units where bricks in large scale are required to be dried at a very rapid rate and throughout the year independent of weather conditions. Artificial drying is carried out in specially designed chambers or tunnels which receive heat from special furnaces built for the purpose.

4. Burning

After moulding and drying, bricks are burnt either in the clamp or in the kiln. Burning not only imparts strength and hardness to the brick but also increases its density.

Clamps

Clamps or Pazwas are temporary working arrangements made for burning bricks. In this method dried bricks and locally available ordinary fuel are stacked together in alternative layers upto a desired height on a properly prepared ground to form a clamp. The clamp is then plastered with mud from outside for its protection. It is ignited from the base and allowed to burn for about a month and then allowed to cool for another month.

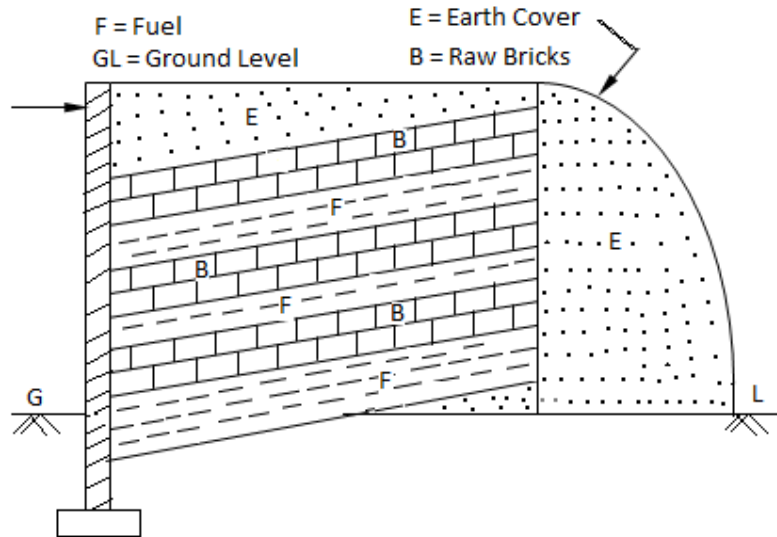

Figure 2.6 Clamp

A characteristic clamp is shown in the Figure 2.6. In this, a sloping ground of trapezoidal shape and slope angle of about 15° is prepared. The narrow end of the trapezium is dug below the ground level and the wider end is raised by filling with the earth so dug. Over the ground so prepared, the first layer of locally available fuel such as straw, wood, leaves, branches, etc. is laid up to a height of about 1 m. Three to five layers of sun dried bricks are properly stacked over such fuel layer leaving sufficient open spaces between the brick layers. Over this, another layer of fuel of slightly smaller height is laid. The arrangement of alternate layers of fuel and bricks is repeated till the required height is achieved. The clamp is then plastered with mud from outside and the clamp is ignited from the narrow end at the base. It is allowed to burn for a month and then allowed to cool for a month.

Kilns

Unlike clamps, kilns are permanent structure used for burning bricks. Kilns are mainly divided into two broad categories based on their principle of their construction. They are: **intermittent kilns**, and the **continuous kiln**. An intermittent kiln is one, which produces bricks after a definite interval of time. On the other hand, a continuous kiln is the one, which produces bricks continuously. Continuous kiln consists of a number of chambers. Burning in

a continuous kiln involves five stages of operations such as loading, burning, preheating, cooling and unloading. The operations in the chambers are so controlled that at a given time, different chambers perform different functions. For example, when one chamber is in the loading process, another chamber may be in the burning stage, the third chamber is in the preheating stage, the fourth chamber in the cooling stage and the fifth chamber in the unloading or supply stage. The operations are shifted from chamber to chamber in such a way that at any time one chamber is available for unloading.

Intermittent kiln

Allahabad kiln is a common type of intermittent kiln and is widely used. It is generally rectangular in shape and has four permanent walls. It may be constructed totally underground or partly underground and partly over ground. The longer walls are raised perpendicular to the directions of prevailing winds. The kilns are provided with a number of openings called flues, exactly opposite to each other with a view of charging fuels and controlling air. These openings are provided with dampers or door sheets, which can be raised or lowered.

The shorter walls are provided with doors for loading and unloading the bricks. The floors provided with narrow and deep grooves in the transverse direction running from one opening to the other in the long walls. The place between any two grooves makes a raised platform of about 1 m width. This is called rouse.

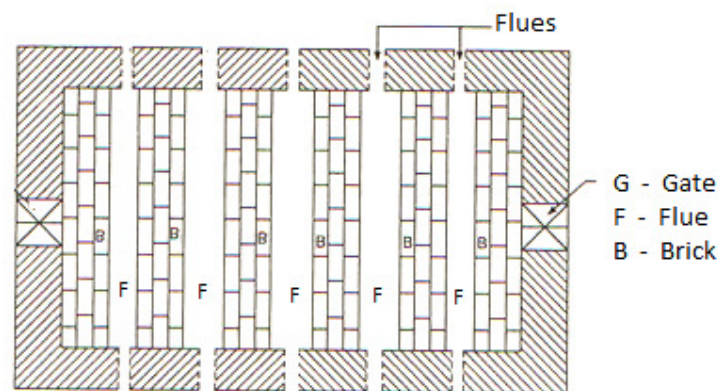

Figure 2.7 Intermittent kiln (Allahabad Kiln)

IV. CLASSIFICATION OF BRICKS

According to the IS: 1077 , 1971 of Bureau of Indian Standard bricks are classified into the following classes.

Class of brick	Characteristics	Uses
First class	<ol style="list-style-type: none"> 1. It is well burnt having smooth and even surface with perfectly rectangular shape and uniform reddish colour. 2. Its surface is smooth, clean and free from cracks. 3. When two bricks are stuck against each other a ringing sound is produced. 4. Its compressive strength shall not be less than 140 kg/cm². 5. It should not absorb more than 20% of water by weight when immersed in water for 24 hours. 6. When scratched by finger nail, there should be no mark left on it. 7. When broken into two pieces, it should show uniform compact structure. 8. Show only slight efflorescence. 	<ol style="list-style-type: none"> 1. Excellent in all types of construction in exterior walls 2. Used in R.B work 3. Used as ballast for R.C work 4. Used for flooring and walling purposes
Second Class	<ol style="list-style-type: none"> 1. It is well burnt or slightly over burnt, not perfectly rectangular shape, having rough surface and does not have uniform reddish colour. 2. Metallic ringing sound is produced when two bricks are stuck against each other. 3. Compressive strength shall not be less than 70 kg/cm². 4. It should not absorb more than 20% of water when immersed in water for 24 	<ol style="list-style-type: none"> 1. These are used in internal walls not exposed to atmosphere. 2. Should be plastered, if used in facing work. 3. These are not used in R.B work. 4. These bricks may be laid in mud and lime mortar.

	<p>hours.</p> <ol style="list-style-type: none"> 5. Shows only slight efflorescence. 6. It is not free from lumps and cracks. 	
Third class	<ol style="list-style-type: none"> 1. These bricks are not burnt in kiln and are slightly under or over burnt. 2. These are soft and can be easily broken. 3. They are light in colour with yellowish tinge. 4. When struck against each other, they do not produce ringing sound. 5. It should not absorb more than 25% of water by weight when immersed in water. 6. Efflorescence is moderate. 7. Compressive strength is between 35 to 50 kg/cm². 	<ol style="list-style-type: none"> 1. It is used in inferior construction work and at places of less rainfall.
Jhama or over burnt brick	<ol style="list-style-type: none"> 1. Due to over burning, these bricks loose shape and get twisted. 2. They are dark in colour. 3. These are quite strong in compressive strength and have compressive strength more than 150kg/cm². 4. These bricks have low porosity and water absorption. 	<ol style="list-style-type: none"> 1. These bricks are not used in building construction. 2. They may be used as road metals, and in foundation and floor soling.

V. QUALITIES OF GOOD BUILDING BRICKS

1. It should have perfectly rectangular shape, regular surface and red coloured appearance.
2. It should conform to the specified size i.e., 19 x 9 x 9 cm for modular bricks.
3. It should be perfectly burnt. To confirm proper burning, two bricks are struck against each other. A metallic ringing sound confirms proper burning where as a dull thug indicates improper burning.

4. A good building brick should not absorb water more than 20% of its dry weight when immersed in water for 24 hours. In no case, it should be more than 25%.
5. The compressive strength of a building brick in no case be less 35 kg/cm². A rough test for the strength of brick is to drop the brick from a height of 1 m on a hard surface. Upon falling, it should not break.
6. It should leave no mark when scratched by fingernail. This shows that the brick is hard enough for building construction.
7. A good brick has a uniform colour and structure throughout. To check this, a brick is taken from the lot and broken into two halves. The broken surfaces in both halves should have same appearance and structure.
8. Efflorescence should be minimum. It shows that the salts of alkaline are less.
9. A good brick should be able to resist the effects of weathering agents like temperature variation, rain, frost action, etc.
10. A good brick should have adequate resistance to fire. Ordinary bricks can resist temperature upto 12000 C.

VI. USES OF BRICK BATS AND SURKHIS

VII. USES OF HOLLOW BRICKS

Hollow bricks are also known as cavity bricks or cellular bricks. They have a few well defined sets of holes of specified dimensions made in their body. Hollow bricks are made of special type of brick earth having higher percentage of clay. Net weight of a hollow brick is about one-third to one-half of the solid brick of same dimension. A hollow brick differs from a perforated one in the sense the body of the brick. Hollow bricks have following advantages in their favour. A typical hollow brick is depicted in the Figure 2.8.

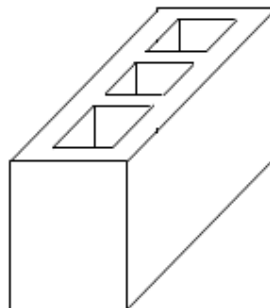

Figure 2.8 Hollow Bricks

Advantages

- i. It is light in weight and can be more conveniently handled.
- ii. It offers better insulation against heat, sound and dampness of the building.

Uses

They are used for construction of load bearing walls, partition walls or panel walls in multi-storeyed building. They are also used in building for better insulation against heat, sound and dampness.

CHAPTER -3

CLAY PRODUCTS AND REFRACTORY MATERIALS

=> The products which are prepared from clay are known as clay product.

=> The clay when made wet with water it possess plastic in nature and this plastic clay can be moulded in any shape, then dried and burnt.

The clay products which are employed in the construction of buildings are tile, terra cotta, porcelain, glazing etc.

TILE:-

-> It may be defined as the thin slab of brick which are burnt in kiln.

-> The manufacturing process of tile is just similar to brick i.e

(i) Preparation of clay.

(ii) Moulding

(iii) Drying

(iv) Burning

-> The tile can be classified as two types

(i) Common tile

(ii) Encaustic tile

COMMON TILE:-

->These tiles have different shape and size and mainly used in paving and flooring .

ENCOUSTIC TILE

->These tiles are used for decorative purpose , i.e in floors, walls, ceiling etc.

->These tiles are manufactured from carefully prepared clay,colouring materials and other ingredients.

=> The cost of these tiles are more than common tiles.

=> These tiles provide uniform appearance.

TYPES OF COMMON TILE

Depending upon the use there are 3 different types of tile .

*Drain tile

*Floor tile

*Roof tile

DRAIN TILES

-> The tiles which are used for drains purposes are known as drain tiles.

-> Generally these are used in water logged areas.

=> These tiles may be circular or semicircular in shape .

=> These tiles are also used in Irrigation structures.

FLOOR TILES

-> The tiles which are used for flooring purposes are known as floor tiles.

-> These tiles may be of square or hexagonal in shape.

-> These tiles are hard.

=> these tiles are available in different colours.

=> These tiles do not require polishing & the floor is ready to use from the next day of laying.

ROOF TILES

-> The tiles which are used for roofing purposes are known as Roof Tiles.

-> These tiles are heat proof.

=> The various tiles which are available in the market are Flemish tiles , pot tiles, corrugated tiles etc.

CHARACTERISTICS OF A GOOD TILE

A good tile should have the following characteristics.

* It should be regular in shape and size .

* It should be hard.

* It should well burnt.

*It should be free from any cracks .

TERRA COTTA:-

-> Terra cotta mean baked earth.

-> It is a type of clay product which is glazed with Galena.

=> It is a soft material.

=> The manufacturing process of terra cotta is also similar to that of brick.

Properties

-> It is light in weight.

-> It is fire proof.

-> It can be easily clean.

=> It can be easily moulded in desired shape.

=> It cannot be affected by atmospheric agents.

USES OF TERRA COTTA:-

-> It is adopted for all types of ornamental work.

->It is used as a decorative material in pillars, columns etc.

TYPES OF TERRA COTTA:-

There are 2 types of terra cotta.

1. Porous terra cotta.

2. Polish terra cotta.

POROUS TERRA COTTA:-

->To prepare porous terra cotta the saw dust are added in clay before the stage of moulding.

->When the articles from such clay are burnt in a kiln, the organic particles are burnt and they leave pores in the articles.

=> This terra cotta is fire proof.

=> It is very light in weight & structurally weak.

POLISH TERRA-COTA

->This is also known as fine terra-cotta.

->To prepare this type of terra-cotta the articles are burnt in the kiln at a temperature about 650°C.

=> Then the articles are removed from the kiln & are allowed to cool down.

=> They are then coated with glazing compounds & burnt again in the kiln at a temperature about 1200°C.

=> It is unaffected by the adverse atmospheric conditions.

EARTHEN WIRE:-

-> The earthen wire is used to indicate the articles prepared from clay which is burnt at low temperature & cooled down slowly.

-> This clay is mixed with required quantity of sand, crushed pottery etc.

=> The addition of such materials prevents cracking during burning.

=> The earth wires with based material become impervious to water & they are not affected by atmospheric action.

=> These are used for ordinary drain pipes, partition blocks etc.

STONE WIRE:-

-> The term stone wire is used to indicate the articles prepared from clay which are mixed with stones and crushed pottery.

-> This mixer is then burnt at a high temperature and cooled down slowly.

=>The stone wires are strong, durable & fire resistant.

=> They are used as jars to store chemicals, wash basins etc.

PORCELAIN:-

The term porcelain is used to indicate the earthen wire which is white, thin and semitransparent.

->As the colour of porcelain is white it also known as white wire.

->It is hard and non-porous material.

=> It is hard & non porous.

->These are used in various purposes like sanitary fittings, insulating boards etc.

->These are of two types

*Low voltage porcelain

*High voltage porcelain

Low voltage porcelain :-

- ⇒ It is prepared by dry process & at low voltage.
- ⇒ If some low quantity of alumina is added then it can resist high temperature to a certain extent.
- ⇒ These are mainly used for switch boards, insulating tubes etc.

High voltage porcelain :-

- ⇒ It is prepared by wet process at high temperature.
- ⇒ It can resist high temp. & voltage.
- ⇒ These are used in the construction of atomic reactors, plugs etc.

GLAZING :

->A glaze is a glassy coat thickness about 0.1 to 0.2mm applied on the surface of the clay products.

->The glazing is done for following purposes

- *To improve the appearance
- *To make the article more durable
- * To protect the articles from weathering action.

TYPES OF GLAZING

- *Transparent glazing
- *Opaque glazing

TRANSPARENT GLAZING

->When a glazing material from transparent colour is provided in the surface of clay product it is called as transparent glazing.

->The appearance of this glazing is like glass.

->It gives less strength.

=> This glazing is rarely used as it provides less safety to the articles.

OPAQUE GLAZING

->This type of glazing is adopted to give butter appearance than that given by the burnt material.

->The clay is finely powder and dried. Then the sufficient quantity of water is added to clay to make a plastic substance.

->The articles which are to be glazed are dipped in this substance before burning and then heated.

=> The burning of articles gives the flow of clay particle & an opaque glaze is formed.

=> For obtaining coloured glazes, a special colour pigment is added like iron oxide, which gives red colour, copper oxide, which gives green colour etc.

REFRACTORY MATERIAL

->The materials which are able to resist high temperature are known as refractory material.

->The refractory material can possess the following properties.

- *Its melting point should be high.
- * It should be strong and durable.
- * It must possess resistance to weathering action.

USES:-

->These are used in blast furnaces.

CLASSIFICATION OF REFRACTORY MATERIAL :-

->These are classified into following two ways.

- *According to chemical properties
- *According to resistance to temperature.

ACCORDING TO CHEMICAL PROPERTIES :-

->These are 3 types.

- *Acidic material – e.g Silica, quartzite.
- *Basic – e.g magnesia Dolomite.
- *Neutral material – e.g Carbon, chromite, boxite.

ACCORDING TO RESISTANCE TO TEMPERATURE

->These are divided into 2 types

- *Low quality refractory material
- *High quality refractory material

Low quality refractory material :-

- ⇒ The material whose melting point is more than 1580°C is known as low quality refractory material.
- ⇒ This material is used for manufacturing fly ash brick & also used for electric boards.

High quality refractory material :-

- ⇒ The material whose melting point is about 1600°C is known as high quality refractory material.
- ⇒ These materials are used for the construction of rockets, jets etc .
- ⇒ This type of material is also used in the manufacturing of vehicles.

CHAPTER-4

CEMENT

Composition of cement :-

The cement consists of the following chemicals

- ° Lime - CaO- 62%
- ° Silica - SiO₂-22%
- ° Alumina - Al₂O₃ -5%
- ° Calcium sulphate-CaSO₄-4%
- ° Iron Oxide-Fe₂O₃-3%
- ° Magnesia-MgO-2%
- ° Sulphur-S-1%
- ° Alkaline and other material-1%

Types of cement:-

According to the creation of the cement it is classified into two type.

- * Natural cement
- * Artificial cement

Natural Cement :-

The natural cement is obtained by burning and crushing the stones containing clay carbonates of lime and some amount of carbonates of magnesia.

- * The quantity of clay in natural cement is 20-40%.
- * The color of this cement is brown.
- * This cement sets rapidly when mixed with water.
- * The cost of this type of cement is very high.
- * This type of cement is rarely used in India.

Artificial cement:-

-> This type of cement is prepared in different varieties.

-> The manufacturing of this types of cement includes the following process.

- * Mixing of raw materials.
- * Burning.
- * Crushing.
- * Grinding.

Types of artificial cement:-

- :- Acid resistant cement.
- :- Blast furnace cement.
- :- Coloured cement.
- :- Expanding cement.
- :- High alumina cement.
- :- Hydrophobic cement.
- :- Low heat cement.
- :- Pozzuolana cement.
- :- Quick setting cement.
- :- Rapid hardening cement.
- :- Sulphate resisting cement.
- :- White cement.

Acid resisting cement:-

An acid resisting cement is composed of the following ingredients.

- i. Acid resisting aggregate.
- ii. Additives like sodium fluosilicate.
- iii. Aqueous solution of sodium silicate.

The addition of fluosilicate accelerates the hardening process of sodium silicate & it also increases the resistance of cement to acid & water.

Blast furnace cement:-

-> For this cement the slag which is obtained from blast furnace is used.

-> The slag is a waste product in the manufacturing process of iron.

=> The clinker of cement is mixed with 60 – 65 % of slag.

=> The strength of this cement is less & it requires longer quiring period .

Coloured cement:-

-> The cement of desired colour is obtained by mixing the mineral pigments with ordinary cement.

-> The amount of colouring material is between 5-10%.

=> The coloured cement is widely used for finishing of floors, external surfaces etc.

=> The chromium oxide gives green colour , cobalt gives blue colour & iron oxide gives brown red or yellow colour in different proportions.

Expanding cement:-

-> This type of cement is produced by adding the expanding material or ingredients likes sulpher alluminate to ordinary cement.

=> This type of cement is used for the construction of water retaining structures & for repairing the damaged concrete structures.

Hydrophobic Cement :-

⇒ This type of cement contains the admixtures which decreases wetting ability of cement grains.

⇒ Usually the admixtures are oxides, petroliums etc.

⇒ These substances form a thin layer arround cement grains .

⇒ When this cement is used , the water resistance of concrete is increased.

High alumina cement:-

⇒ This cement is produced by grainding the clinkers fromed by calcining bauxite and lime.

⇒ This cement is rarely used in India.

Low heat cement:-

⇒ In this cement a considerable heat is produced during the setting action.

⇒ It contains higher %age of dicalcium silicate & lower %age of tricalcium aluminate.

⇒ This cement possess less compressive strength.

Pozzuolona cement:-

- ⇒ It can be produced by surkhi which is prepared by burning bricks made from ordinary soils.
- ⇒ This cement is used for concrete work under water.
- ⇒ The %age of pozzuolana material should be between 10 to 30.
- ⇒ It is cheap.

Quick setting cement:-

- ⇒ This cement is produced by adding small percentage of aluminium sulphate and by finely grinding the cement.
- ⇒ The setting action of this cement starts within 5 minutes.
- ⇒ This cement is used to lay concrete under static water & running water.

Rapid hardening cement:-

- ⇒ It is just similar to ordinary cement but it gives more strength than ordinary cement.
- ⇒ It is not damaged easily .
- ⇒ It contains high percentages of tri calcium silicate .
- ⇒ The structures with heavy load are constructed with this cement.
- ⇒ This cement is costlier than ordinary cement & is very light.

Sulphate resisting cement:-

- ⇒ The ordinary cement is mixed with calcium hydroxide and finally grinded.
- ⇒ The cement is used for the structures which are to be damaged by alkaline conditions such as canal linings, culverts , siphons etc.
- ⇒ The cement is used in marine construction.

White cement:-

- ⇒ This cement is prepared from the raw materials which are practically free from colouring oxides of iron, manganese or chromium.
- ⇒ It is used for plastering work, floor finishing etc.
- ⇒ It is also costlier than ordinary cement.

Properties of cement:-

Following are the properties of cement.

1. It is easily workable.
2. It gives strength to the masonry work.
3. It is an excellent binding material.
4. It offers good resistance to the moisture.
5. It possesses good plasticity.
6. It stiffens or hardens early.

Testing of quality of cement :-For testing the quality of a cement, the following tests are carried out in the laboratory :-

- (i) Fineness
- (ii) Consistency
- (iii) Compressive strength
- (iv) Setting times (Initial & Final)
- (v) Soundness

CHAPTER-5

SAND GRAVEL, MORRUM AND FLYASH

Sand :-

-> Generally sand is formed by the decomposition of stone due to various effects of weather.

->The sand particles contains small grains of silica(SiO_2).

->There are 3 catagories of sand according to the natural sources from which it is obtained :

*Pit sand

*River sand

*see sand

PIT SAND

->These are obtained by forming pits.

->The pit is excavated from a depth of 1-2m from the ground.

->These pit sand consists of sharp , angular grains, which are free from salt.

-> these are excellent material for mortar of concrete work.

->These pit sand is rarely used now a days.

RIVER SAND

->This sand is obtained from river beds.

->This sand consists of fine rounded grains due to the action of water current.

-> The colour of river sand is white.

-> This sand is commonly used in cleaned condition, so it is used for all purposes.

SEE SAND

->This sand is obtained from see shores.

->These sand is also consist of fine rounded grains.

->The colour of this sand is light brown.

->This sand retards the setting action of cement.

CLASSIFICATION SAND ACCORDING TO THE SIZE OF GRAIN

According to the grain size of sand particles it is classified to 3 type.

*Fine sand

*course sand

*Gravelly sand

=> The sand passing through a screen of opening of 1.5 mm is called as fine sand. These are mainly used in plastering purpose.

=> The sand passing through a screen of clear opening of 3.71 mm is called as course sand. It is mainly used for masonry work.

=> The sand passing through a c screen of clear opening of 7.61 mm is called Gravelly sand. These are commonly used for floorings, paving of road surfaces etc.

BULKING OF SAND :-

The presence of moisture in sand particles increases the volume of sand. It is due to the fact that the moisture causes a thin layer of water around the particles which results in an increase in volume of sand. For a moisture content of about 5 to 8 percent, this increase in volume may be as much as 20 to 40 percent, depending upon the grading of sand. The finer the material, the more will be the increase in volume for a given moisture content. This phenomenon is known as the bulking of sand.

Qualities of sand for plaster & for Masonry work :-

- ⇒ The sand should be clean & coarse. It should be free from any organic or vegetable matter.
- ⇒ It should contain sharp, angular, coarse & durable grains.
- ⇒ It should not contain salts which attract moisture from atmosphere.
- ⇒ It should be well graded i.e, should contain particles of various sizes in suitable proportions. It should pass BIS No. 480 mesh sieve & should not pass BIS No. 15 sieve. The fineness modulus of sand should be between 2 & 3.

Grading of sand for plaster & for Masonry work :-

- ⇒ In order to obtain the concrete of good qualities, the sand should be properly graded.
- ⇒ For increasing the strength of concrete structure, the gradation should be required.
- ⇒ The grading of sand is expressed in terms of BIS test sieve No. 480, 240, 120, 60, 30, 15.
- ⇒ The grading of sand has a marked effect on the uniformity, workability & finishing qualities of concrete.

GRADING TABLE

BIS sieve No. %age of wt passing through the sieve

No 480	95-100
No 240	70-95
No 120	45-85
No 60	25-60
No 30	5-30
No 15	0-10

USE OF GRAVEL :-

->There are 6 type of gravel

- *1crushed gravels :- These are used in redimixed concrete.
- *1round gravel :- These are used in roofing, decorating purposes etc.
- *2 crushed gravel :- These are used for manufacturing of basement materials in drains .
- *2round gravel :- These are used for roofing, decorating purposes .
- *3crushed gravel :- These are used for basement material in roads .
- *3round gravel :- These are used for decorating purposes in playgrounds.

USE OF MORRUM :-

- >It is used as paving material in the construction of road.
- >It is used as basement material in drains.
- >It is used for filling underground tanks.
- > It is used for under laying surface of foundation.
- > It is used for flooring purposes in buildings.

USE OF FLY ASH

- >It is used as an admixture in concrete.
- >It also improves the strength of concrere.
- > It improves the water tightness of concrete.
- > It permits the easier placing & finishing of concrete.
- > It is used for manufacturing the building bricks.

CHAPTER-6

MORTAR AND CONCRETE

6.1 Definition & Composition

Mortar is a mechanical mixture of cement and sand having different proportion prepared by adding required quantity of water. It is also known as binding material like cement or lime.

Mortar is used as a binding material for brick masonry and stone masonry, as a covering material to walls in the form of plaster to provide a smooth, hard and decorative.

6.2 Properties of good building Mortar

Following are the properties of good building mortar required

1. It should be easily workable.
2. It should develop adequate strength in tension, compression and bond for the work for which it is used.
3. It should set quickly so that the speed of construction is ensured.
4. It should be durable and not affect the durability of other materials.
5. It should bind the stone and brick to give a tight joint through which water cannot penetrate.
6. It should be capable of developing the designed stressed.
7. It should be cheap.

Uses of Mortar

The following are the uses of mortar

1. It is used to fill up the spaces between bricks and stones for making wall weather tight.
2. It is used to bind together the bricks in brick masonry.
3. It is used in concrete as a matrix.
4. It is used to form joints of pipes.
5. It is used to improve general appearance of structure.
6. It is used to hide open joints of a brickwork and stonework.
7. It is used to serve as a matrix or cavity to hold coarse aggregates.
8. It is used to bind the building units such as bricks, stones, etc. into a solid mass.
9. It is used to fill up cracks detected in the structure during maintenance process.

INGREDIENTS OF MORTAR

The ingredients of various mortars used for different engineering purpose are as follows

1. Binding materials (Cement, Lime)
2. Fine aggregates (Sand, Surkhi, Ashes, Cinder)

Binding materials

Cement mortar:

In this type of mortar, cement is used as a binding material. Depending upon the strength required and importance of work, the proportion of cement to sand by volume varies to different proportions. The surkhi and cinder cannot be used in cement mortar because they are not chemically inert substances.

Function: In cement mortar, cement performs the following functions:

- It makes the mortar impermeable by filling up the voids existing in the fine aggregate.
- It imparts strength to the mortar on setting and hardening.

Lime mortar:

It is also used as a binding material in preparing the mortars for various purposes but its strength is less than that of cement mortar. The surkhi is used as the fine aggregate in this case.

Fine Aggregates (SAND)

Sand is the most important fine aggregate which is used in cement mortar. The sand forms an important ingredient of mortar.

Classification of Sand:

According to the size of grains, the sand is classified as fine and coarse and gravelly.

1. The sand passing through a screen with clear openings of 1.5875mm is known as the fine sand. It is mainly used for plastering.
2. The sand passing through a screen with opening of 3.175mm is known as the coarse sand. It is generally used for masonry work.
3. The sand passing through a screen with opening of 7.62mm is known as the gravelly sand. It is used for concrete work.

Properties of good Sand

Following are the properties of good sand

1. It should be chemically inert.
2. It should be clean and coarse.
3. It should be free from any organic or vegetable matter.
4. Usually 3 to 4% clay is permitted.
5. It should contain sharp, angular, coarse and durable grains.
6. It should not contain salt.

Function of sand in Mortar:

The sand is used in mortar for following purposes:

1. **Bulk:** It does not increase the strength of mortar. But it acts as adulterant. Hence the volume of mortar is increased which results in reduction in cost.
2. **Setting:** If building material is fat lime, the carbon dioxide is absorbed through the voids of sand and setting of fat lime occurs effectively.
3. **Strength:** it helps in the adjustment of strength of mortar by variation of its proportion with cement or lime. It also increases the resistance of mortar.
4. **Surface area:** It subdivides the paste of the binding material in to a thin film and thus more surface area is offered for its spreading.
5. **Shrinkage:** It prevents excessive shrinkage of the mortar in the course of drying and hence the cracking of mortar during setting is avoided.

PERCAUTIONS IN USING MORTAR:

Following are the precautions are to be taken while making use of mortar:

1. **Consumption of mortar:** after preparation, the mortar should be as early as possible. The lime mortar should be consumed within 36 hours after its preparation and it should be kept wet or damp. The cement mortar should be consumed within 30 minutes.
2. **Frost action:** The setting action of mortar is affected by the presence of frost. It is therefore advisable to stop the work in frosty weather or to execute it with cement mortar.
3. **Workability:** The mortar should not contain excess water and it should be selected or recommended.

CONCRETE

Definition

The cement concrete is a mixture of cement, fine aggregate (sand), coarse aggregate (crushed rock) and water, which are well proportioned and mix properly. It become hard like a stone after proper curing.

CHARACTERISTICS OF GOOD CONCRETE

A good concrete should have following characteristics:

1. It should be high compressive strength. The compressive strength should not be less than 15.5 N/mm^2 .
2. On hardening, it should exhibit minimum shrinkage.
3. It should be economical for the desired strength.
4. It should have minimum thermal expansion so as to provide good resistance to fire.

5. It must be adequately dense. The density of good concrete should be about 24kN/m^3 .
6. It should sufficiently hard and provide enough resistance to abrasion.
7. This property is of paramount importance when concrete is to be used for making steps of stairs and road pavements.
8. It must be adequately durable to resist the effects of weathering agents.
9. It should have provided the required finish to the concrete structure.
10. It should minimum creep.
11. It is proved to be more economical than steel. This is due to the fact that sand and aggregates, forming the bulk of cement concrete, to the extent of about 80 to 90%.

ADVANTAGES OF CONCRETE:

Following are the advantages of concrete

1. It has high compressive strength.
2. As compared to other materials, concrete is economical in long run.
3. It is durable and fire resistant and requires very little maintenance.
4. The green concrete can be easily handled and moulded into any shape or size according to specifications.
5. The concrete can be pumped and hence it can be laid in the difficult positions also.
6. Concrete can even be sprayed on and filled into the cracks for repairs by the grading process.
7. Being stored in compression, it has unlimited structural applications in in combination with steel reinforcement.

DIS-ADVANTAGES OF CONCRETE:

Following are the disadvantages of concrete

1. Concrete is to be reinforced with steel bars or meshes since it has low tensile strength and hence cracks easily developed.
2. Provision for construction joints has to be made to avoid the development of cracks due to drying shrinkage and moisture movement in fresh concrete.
3. In order to avoid the formation of cracks due to thermal movement , expansion joints have to be provided.
4. Concrete is liable to disintegrate by alkali and sulphate attack.
5. Concrete as a material lacks in ductility and this factor provides disadvantageous with respect to earthquake resistance.

USES OF CONCRETE:

Following are uses of concrete

- Foundation
- Building
- Road
- Artificial
- Airfield
- Water retaining structures
- Dock and harbour
- Dams
- Bridges
- Bunkers

GRADING OF AGGREGATES:

In order to obtain concrete of denser quality, the fine and coarse aggregates are properly graded. The grading of fine aggregate is expressed in terms of BIS test sieves nos. 480, 240, 120, 60, 30 and 15.

GRADING LIMITS FOR FINE AGGREGATES

BIS sieve	Percentage by weight through sieve	
	Natural or crushed gravel sand	Crushed stone sand
No. 480	95-100	90-100
No. 240	70-95	60-90
No. 120	45-85	40-80
No. 60	25-60	20-50
No. 30	5-30	5-30
No. 15	0-10	0-15

WATER-CEMENT RATIO:

1. It is the ratio of water to cement and is expressed as ratio of the weight or volume of water to the weight or volume of cement in concrete mixture.
2. Generally it is expressed as so many litres of water per cement bag (50kg).
3. It is found theoretically that water required for these two functions is about 0.50 to 0.60 times the weight of cement.
4. The quantity of water required in litres per bag of cement as 1 litre of water weighs 1 kg. For instance, if water required for 1 bag of cement is 30 litres, the water-cement ratio is equal to $\frac{30}{50} = 0.60$

REINFORCED CEMENT CONCRETE (R.C.C.)

Concrete is good in resisting compression but is very weak in resisting tension. Hence reinforcement is provided in the concrete wherever tensile stress is expected. The best reinforcement is steel, since tensile strength of steel is quite high and the bond between steel and concrete is good. As the elastic modulus of steel is high, for the same extension the force resisted by steel is high compared to concrete. However in tensile zone, hair cracks in concrete are unavoidable. Reinforcements are usually in the form of

mild steel or ribbed steel bars of 6 mm to 32 mm diameter. A cage of reinforcements is prepared as per the design requirements, kept in a form work and then green concrete is poured. After the concrete hardens, the form work is removed. The composite material of steel and concrete now called R.C.C. acts as a structural member and can resist tensile as well as compressive stresses very well.

DEFINITION OF PRESTRESS:

Prestress is defined as a method of applying pre-compression to control the stresses resulting due to external loads below the neutral axis of the beam tension developed due to external load which is more than the permissible limits of the plain concrete. The pre-compression applied (may be axial or eccentric) will induce the compressive stress below the neutral axis or as a whole of the beam c/s. Resulting either no tension or compression.

Basic Concept

Prestressed concrete is basically concrete in which internal stresses of a suitable magnitude and distribution are introduced so that the stresses resulting from the external loads are counteracted to a desired degree.

CHAPTER-7

TIMBER

Definition:

The word timber is derived from an old English word timbrian which means to build. The timber denotes wood which is suitable for building or carpentry on various engineering purpose and it is applied to the trees measuring not less than 600mm in the circumference of the trunk.

Characteristics of good Timber:

Following are the characteristics of good timber

1. It should be heavy and uniform colour.
2. It should have regular annular rings.
3. A freshly cut surface should give a sweet smell.
4. It should have straight and close fiber.
5. It should be sonorous when struck.
6. It should be heavy in weight.
7. It should be free from shacks, flaws, dead, knots of any kind.
8. The cellular tissue of the medullary rays should be hard and compact.
9. When planed, its surface should present a firm bright appearance with a silky lustre.
10. A good timber should be strong for working as structural member such as joints, beams, rafters, etc. it should be capable of taking loads slowly or suddenly.

Advantages of Timber:

Following are the advantages of timber

1. It is light in weight yet strong.

2. It is easily available and can be quickly transported by simple means.
3. The floor joints in an average dwelling weighs less than rolled-steel beams of equal strength.
4. Boards may be cut rapidly by a saw and fastened firmly together with nails.
5. It is a good insulator of heat and sound.
6. When properly protected timber structures may be give good service for hundred of years.
7. It stands shocks and bumps, a good deal better than iron and concrete.
8. Repairs, additions and alterations to timber construction are easy.
9. On account of its light weight, timber is generally preferred for building works in earthquake region.
10. It is considered to be an ideal material of construction in sea water or marine works as it can resist corrosion.

Dis-Advantages of Timber:

Following are the dis-advantages of timber

1. The greatest disadvantage is its ready combustibility, which can be diminished but not eliminated even by expensive treatment.
2. Frame buildings built closely together present a serious conflagration hazard.
3. Timber swells and undergoes shrinkage with changing atmospheric humidity.

Uses of Timber:

Following are the uses of timber

1. It is generally used in the form of piles, posts, beams, lintels, door-window frames, and leaves, roof members, etc.
2. It is employed for flooring, ceiling, paneling, and construction of partition walls.

3. It is used for formwork for concrete, for the timbering trenches, centering for arch work, scaffolding, transmission poles and fencing.
4. It is used in wagons and coach building, marine installations bridges.

CLASSIFICATION AND STRUCTURE OF TIMBER :

For the engineering purposes, the trees are classified in to **two** categories.

i.e- 1. Exogenous Tree

2. Endogenous Tree

Exogenous Tree:

1. These trees are grow outwards and increase in bulk by the formation of successive annular rings on the outside under the bark.
2. In these trees, each annual ring represents layer of wood, deposited every year.
3. Example:- Deodar, Chir, Sal, Kail, Shishum, Teak.
4. The Exogenous trees may be further classified into two categories:

1. Conifers Tree

2. Deciduous or broad-leafs trees

Endogenous Tree:

1. These trees are grows inwards or endwards.
2. The steams of these trees are too flexible and thus they are not much suitable for engineering works.

Structure of Tree:

A tree basically consists of three parts namely :- trunk, crown, and roots.

From the visibility aspect, the structure f a tree can be divided into two categories:

I. Macrostructure

II. Microstructure

Macrostructure:

Following are the different components



1. **Pith:-** The innermost center person or core of the tree is called the pith or medullar. It varies in size and shape for different types of trees, it consist entirely of cellular tissues and it nourishes the plant in its young age when the plant becomes old the pith dies up.
2. **Heart wood:-** The inner annual rings surrounding the pith constitute the heart wood. It is usually dark in colour it indicate dead portion f tree. But it provides strong and durable timber for various engineering purpose.



3. **Sap wood:-** The outer annual rings between heart wood and cambium layer is known as the sap wood. It is usually light in colour and weight. It indicates recent growth of sap woods are less sharply defined than those of heart wood.
4. **Cambium layer:-** The thin layer of sap between sap wood and inner bark is known as cambium layer. If the bark is removed for any reason the cambium layer gets exposed and the cells cease to be active resulting in the death of tree.
5. **Inner bark:-** The inner skin or layer covering the cambium layer is known as the inner bark. It gives protection to the cambium layer from any injury.
6. **Outer bark:-** The outer skin or cover of the tree is known as the outer bark. It is the outer most protective layer and it sometimes contains cracks. It is also known as the Cortex.
7. **Medullary ray:-** The thin radial fibers extending from pith to cambium layer are known as the medullar rays. The functions of these rays are to hold together the annual rings of heart wood and sap wood. These rays are sometimes broken.

Micro structure:

The structure of wood apparent only at great magnification is called the microstructure. It is studied under a micro scope in which living and dead cells are present.

A living cell consists of the following 4 parts:

- I. Membrane
- II. Protoplasm
- III. Sap
- IV. Core

The dead cell consists of following 3 parts:

- I. Conductive cell
- II. Mechanical cell

III. Storage cell

7.2 Defects in Timber:

The defects occurs in timber are grouped in to following five categories

1. Defects due to conversion
2. Defects due to fungi
3. Defects due to insects
4. Defects due to natural forces
5. Defects due to seasoning

(1) Defects due to conversion: In this case, the following defects may occurs:

- I. Chip mark
- II. Diagonal grain
- III. Torn grain
- IV. Wane

(2) Defects due to fungi: The fungi are minute microscopic plant organism. They attack timber only when the following two conditions are satisfied.

- I. The moisture content f timber is above 20%.
- II. There are presences of air and warmth for the growth of fungi.

Following defects are occurs in the timber by fungi:

- I. Blue stain
- II. Brown rot
- III. Dry rot

- IV. Heart rot
- V. Sap rot
- VI. Wet rot
- VII. White rot

(3) Defects due to insects: Following are the insects which are usually responsible for the decay in timber;

- I. Beetles
- II. Marine borers
- III. Termites

(4) Defects due to natural forces: The main natural forces responsible for causing defects in timber. Following are the defects are caused by these forces:

- I. Burls
- II. Callus
- III. Chemical Stain
- IV. Coarse Grain
- V. Dead Wood
- VI. Druxiness
- VII. Foxiness
- VIII. Knots
- IX. Rind Galls
- X. Shakes
- XI. Twisted Fiber

- XII. Upsets
- XIII. Water Stain
- XIV. Wind Crack

(5) Defects due to seasoning: Following are the defects occurs due to seasoning:

- I. Bow
- II. Case-hardening
- III. Check
- IV. Collapse
- V. Cup
- VI. Honey-combing
- VII. Radial Shakes
- VIII. Twist
- IX. Warp

Rind gall:

A defect in timber caused by a bruise in the bark which produces a callus on the wood over which later layers grow without consolidating. Or

A defect in timber caused by a bruise in the bark which produces a callus upon the wood over which the later layers grow without consolidating. Laslett, Timber and Timber Trees.

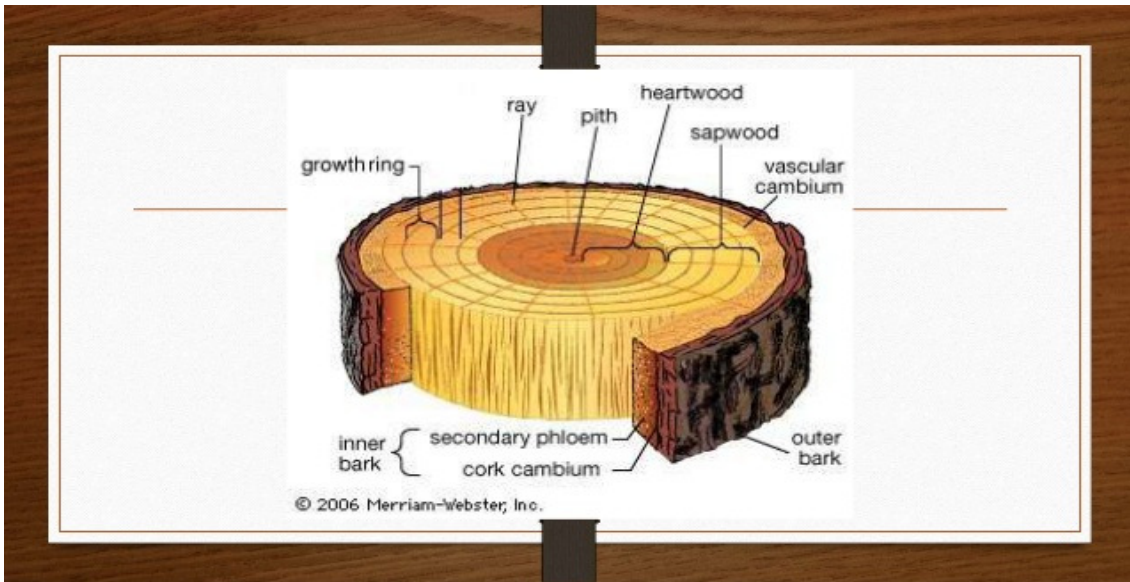

Knots

Knots are cut or broken off limbs or sprout branches, green or dead, protruding, flush, or depressed, but with exposed sound or rotten wood. If the exposed wood is sound, the knot is "sound"; if rotten, it is "unsound".

Knots are common blemishes in trees, often causing lumps or holes within the trunk of the tree itself. In most cases knots are caused by the natural growth of the tree, though the specific circumstances under which they form determines how they will appear. Some knots are formed by fungal infections, however, and can spread to other trees on your property as well.



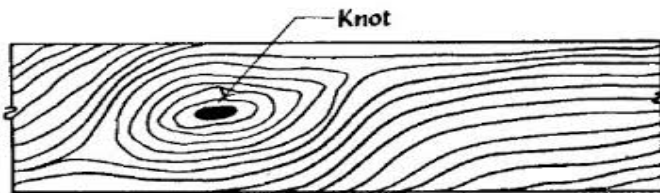

Quality of good Timber:

In general, the quality of good timber depends upon the following factors

1. Environmental condition of the locality.
2. Maturity of the tree.
3. Method of seasoning.
4. Nature of soil.
5. Process of preservation.
6. Time of felling.

7.3 Decay of Timber:

The timber is said to be decayed when it is so deteriorated that it loses its value as an engineering material.



Following are the various causes which favored the early decay of the timber:

1. Alternate dry and wet condition.
2. Bad storage or stacking of timber.
3. Improper seasoning.
4. Keeping timber in contact with dampness.
5. Use of timber without taking sap wood from its structure.
6. Using unseasoned timber without applying suitable preservative on its surface.

Preservation of Timber:

The preservation of timber is carried out to achieve the following three objectives:

1. To increase the life of timber structures.
2. To make the timber structures durable.
3. To protect the timber structures from the attack of destroying agents.

Requirements of a good Preservation;

Following are the requirements of a good preservation:

1. It should be capable of covering a large area with small quantity.
2. It should be free from unpleasant smell.
3. It should be non-inflammable.
4. It should be quit efficient in killing fungi, insects etc.
5. It should not affect the strength characteristic of timber.

7.4 Seasoning of timber:

1. Seasoning of timber is the process of drying timber or removing moisture or sap, present in a freshly felled timber, under more or less controlled conditions.

- Freshly felled timber contains a large quantity of moisture roughly from 100 to 200% based on dry weight of timber.

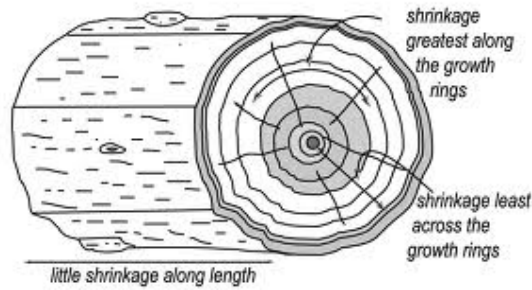

Objectives of seasoning

Following are the objectives of seasoning

- To minimize the tendency of timber to shrink.
- To increase the strength.
- To make the timber safe against fungi and insects.
- To make the timber easily workable in any shape.
- To make the timber suitable for gluing.

No.	Type of timber	Thickness in mm			
		12	25	38	50
1	Non-refractory	6 Days	8 Days	12 Days	17 Days
2	Moderately refractory	7 Days	10 Days	14 Days	18 Days
3	Highly refractory	9 Days	12 Days	17 Days	22 Days

Diseases of Timber:

The common diseases of the timber are

- I. Dry rot
- II. Wet rot

Timbers are suitable for various uses:

Sl.No.	Application/Uses	Timber
1	Sports goods and baskets.	Ash, Oak, Mulberry.
2	Match industry.	Pine, Simul.
3	Bulk carts.	Babul.
4	Musical instruments.	Jack.
5	Railway sleepers.	Deodar, Kail, Sal, Ash.
6	Well curbs.	Mango, Jack, Simul.
7	Doors and Windows.	Sal, Deodar.
8	Scaffolding	Bamboo, Sal.
9	Agricultural tools	Babu, Ash, Mulberry.
10	High class journey and furniture	Teak, Shishum, Walnut.

7.5 Plywood:

Plywood is made by cementing together several layers of wood which may be thin veneers or thicker boards.

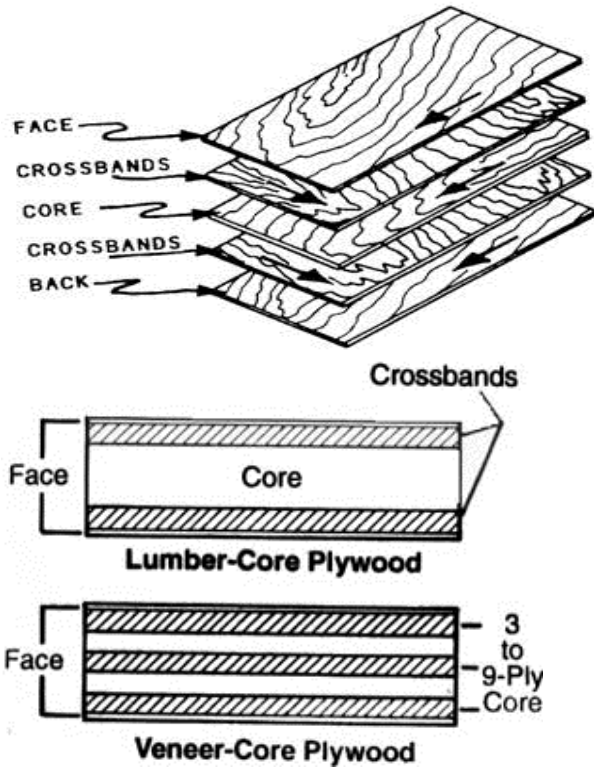

The advantages of plywood are

1. Better appearance.
2. Easily workable and capable of being shared to numerous design.
3. Uniform tensile strength in all direction.
4. Light in weight and greater strength.

CHAPTER-8

PAINTS, VARNISHES AND DISTEMPERS

The paints are coatings of fluid materials and they are applied over the surfaces of timber and metals. The varnishes are transparent or nearly transparent solutions of resinous materials and they are applied over the painted surfaces. The distempers are applied over the plastered surface.

Purpose of Painting a surface :

Following are the objects of painting a surface:

- (i) It protects the surface from weathering effects of the atmosphere and actions by other liquids, fumes and gases.
- (ii) It prevents decay of wood and corrosion in metal.
- (iii) It is used to give good appearance to the surface. The decorative effects
May be created by painting and the surface becomes hygienically good clean, colourful and attractive.
- (iv) It provides a smooth surface for easy cleaning.

CHARACTERISTICS OF AN IDEAL PAINT

Following are the characteristics of an ideal paint:

- (i) It should possess a good spreading power i.e. maximum area of the surface should be covered by minimum quantity of the paint.
- (ii) The paint should be fairly cheap and economical.
- (iii) The paint should be such that it can be easily and freely applied on the surface.
- (iv) The paint should be such that it dries in reasonable time and not too rapidly.
- (v) The paint should be such that its colour is maintained for a long time.
- (vi) The paint should form a hard and durable surface.
- (vii) The paint should not affect health of workers during its application.
- (viii) The paint should not be affected by weathering actions of the atmosphere.
- (ix) The paint should possess attractive and pleasing appearance.
- (x) The surface coated with paint should not show cracks when the paint dries.
- (xi) When applied on the surface, the paint should form a thin film of uniform nature.

INGREDIENTS OF AN ideal PAINT

An Oil paint essentially consists of the following ingredients:

- (1) a base,
- (2) a vehicle or carrier,
- (3) a drier,
- (4) a coloring pigment, and
- (5) a solvent.

(1) **Bases:** A base is a solid substance in a fine state of division and it forms the bulk of a paint. It determines the character of the paint and imparts durability to the surface which is painted. It reduces shrinkage cracks formed on drying and it also forms an opaque layer to obscure the surface of material to be painted

BASES FOR PAINTS

1. White lead
 - i. This is a carbonate of lead and it forms the base of lead paints. It possesses good bulk and is the most widely used base.
2. Red lead
 - i. This is an oxide of lead and it forms the base of lead paints.
 - ii. It is quite suitable for painting iron surfaces and for providing a priming coat to the wood surfaces.
3. Oxide of zinc or zinc white
 - i. This is an oxide of zinc and it forms the base of all zinc paints.
 - ii. It is smooth, transparent and non poisonous.
4. Oxide of iron
 - i. This is an oxide of iron and it forms the base of all iron paints .
5. Titanium white
 - i. This material possesses intense opacity
6. Antimony white
 - i. This is nearly similar to the titanium white.
7. Aluminium powder
 - i. This forms the bulk of aluminium paints.

(2) Vehicles

The vehicles are the liquid substances which hold the ingredients of a paint in liquid suspension. They are required mainly for two reasons:

- (i) to make it possible to spread the paint evenly and uniformly on the surface in the form of a thin layer; and

- (ii) to provide a binder for the ingredients of a paint so that they may stick or adhere to the surface

VEHICLES FOR PAINTS

1 Linseed oil

- (i) This is the most common material used as vehicle of a paint. It is extracted from flax seeds. The linseed oil prepared from fine full-grown ripe seeds is clear transparent, pale, sweet to the taste and practically odourless. It is used in various grades.

2 nut oil

- (i) This oil is extracted from ordinary walnuts. It is nearly colourless and dries rapidly. It does not provide a durable finish and is used for ordinary work as it is cheap.

(3) Driers:

These substances accelerate the process of drying. A drier absorbs oxygen from the air and transfers it to the linseed oil, which in turn, gets hardened.

The various patented driers are available in the market. They may be either in the form of soluble driers or paste driers. The former driers are compounds of metals such as cobalt, lead, manganese, etc. dissolved in linseed oil or some other volatile liquid. The latter driers are compounds of the same metal.

The litharge, red lead and sulphate of manganese can also be used as driers. The litharge is the most commonly used drier, the proportion being 1.25 N to 5 litres of oil. The red lead is less effective than litharge and it is to be used when its addition does not interfere with the tint of the paint. The sulphate of manganese is used with zinc paints so as to eliminate the risk of discolouration of a lead drier.

(4) Colouring pigments:

When it is desired to have a different colour than the base of a paint, a colouring pigment is to be added. The pigments are available in the form of fine powders in various colours and qualities.

(5) Solvents:

The function of a solvent is to make the paint thin so that it can be easily applied on the surface. It also helps the paint in penetrating through the porous surfaces. The most commonly used solvent is the spirit of turpentine.

The turpentine is inflammable, evaporates rapidly and dries the oil consequently. The use of a thinner in paint reduces the protective value of the coating, flattens colours and lessens the gloss of the linseed oil as the spirits evaporate leaving an excess of colour not mixed with the oil.

THE PROCESS OF PAINTING

Brushes: It is necessary to have good brushes for painting. The brushes should be composed of bristles and not of horse hairs. The bristle brushes are elastic and possess good paint-holding capacity. The bristles are splits at ends and in this respect they can be distinguished from horse hairs.

Paints: The readymixed Paints of different make and various brand are available in the market. They are available in different tints and can be applied in the same form as received. The ready paints are normally expensive and they are to be used soon after opening the sealed container because of the fact that volatilisation of the vehicle and solvent will take place when exposed to the atmospheric oxygen. If the ready mix paint is kept exposed to air for a long duration, the solidification of the base and the pigment occurs.

Knotting: The term knotting is used to indicate the covering or killing of all knots in woodwork with a substance through which the resin cannot exude or come out. There are three methods of knotting as mentioned below:

(i) Ordinary or size knotting: This is applied in two coats. For the first coat, the red lead ground in water and mixed with Strong glue size is used in hot condition. This coat dries in about ten minutes and then second coat is applied. The second coat consists of red lead ground in oil and it is thinned by boiled oil and turpentine.

(ii) Patent knotting: This is applied in two coats. For both the coats, the varnish prepared by dissolving shellac in methylated spirits of wine is used.

(iii) Lime knotting: The knot is covered by hot lime and it is left for 24 hours. The surface then scrapped off and then ordinary knotting is carried out.

Stopping: The term stopping is used to indicate the rubbing down of the surface after the

first coat of paint is applied. The rubbing is done by means of pumice-stone or glass-paper or both. Before rubbing is commenced, the holes, cracks, etc. on the surface are filled with ordinary putty made from whiting and linseed oil. The putty becomes hard when it dries.

The term hard stopping is used when instead of ordinary putty, an admixture of one-third white lead and two-third ordinary putty, is filled in holes, cracks, etc. It is adopted for superior work.

Coats: The paint is usually applied in three or four coats. The first coat known as tile priming coat, the second one as under coat and the remaining as finishing coats. The priming coat creates a layer or film which provides adhesion of the paint with the surface. It also protects the surface from weathering actions. The suitable material for priming-coat should be used, depending on the nature of surface to be painted. The under coat serves to provide foundation or support to the finishing coat. The surface is made even and all irregularities of the surface are removed by this coat.

The finishing coat or coats are then applied as per requirement.

VERNISHING : The term varnish is used to indicate the solution of resins or resinous substances

prepared either in alcohol, oil or turpentine.

Following are the main objects of applying varnish on a wooden surface:

(i) It brightens the appearance of the grain in wood.

(ii) It renders brilliancy to the painted surface.

(iii) It protects the painted surface from atmospheric actions.

(iv) It protects the unpainted wooden surfaces of doors, windows, roof trusses, floors, etc., from the actions of atmospheric agencies.

CHARACTERISTICS OF AN IDEAL VARNISH :

Following are the characteristics of an ideal varnish:

- (i) It should render the surface glossy .
- (ii) It should dry rapidly and present a finished surface which is uniform in nature and pleasing in appearance.
- (iii) The colour of varnish should not fade away when the surface is exposed to the atmospheric actions.
- (iv) The protecting film developed by varnish should be tough, hard and durable.
- (v) It should not shrink or show cracks after drying .

INGREDIENTS OF A VARNISH:

Following are the ingredients of a varnish:

- (1) Resins or resinous substances
 - (2) Driers
 - (3) Solvents.
- (1) **Resins or resinous substances:** The commonly used resins are copal, lac or shellac and rosin. The copal is a hard substance and is available from the earth at places where pine trees existed in past. It is available in variety of forms. The lac or shellac is obtained by exudation of some types of insects in India. The rosin is obtained from pine trees. Other resins are amber, mastic, gum dammar, etc.
- (2) **Driers:** The function of a drier in varnish is to accelerate the process of drying. The common driers used in varnishes are litharge, white copper and lead acetate .
- (3) **Solvents:** Depending upon the nature of resin, the type of solvent is decided.

SOLVENTS FOR RESINS

No.	Solvent	Resins
1.	Boiled linseed oil	Amber, Copal
2.	Methylated spirits of wine	Lac or shellac
3.	Turpentine	Mastic, Gum dammar,
Rosin		
4.	Wood naphtha	Cheap varieties of resins

PROCESS OF VARNISHING :

The application of varnish on the woodwork is carried out in the following way:

- (1)**Preparation of surface:** The woodwork is thoroughly rubbed down by means of sand paper or pumice stone. The surface is then made smooth and clean.
- (2) **Knotting:** The process of knotting is then carried out as in case of painting.
- (3) **Stopping:** The surface of woodwork is then stopped. This is done by means of hot weak glue size. It will fill up the pores on the surface. One N of glue will form about one litre of glue size. Alternatively, the boiled linseed oil can be applied in two coats. When the surface becomes dry, it should be once again rubbed down with sandpaper.
- (4) **Coats of varnish:** The varnish is then applied on the surface in thin coats. The next coat is applied after the previous one has thoroughly dried up. The varnishing should not be done with ordinary paint brushes . But fine haired varnishing brushes should be used .

DISTEMPERING :

PURPOSE OF DISTEMPERING :

The main object of applying distemper to the plastered surfaces is to create a smooth surface. The distempers are available in the market under different trade names. They are cheaper than paints and varnishes and they present a neat appearance.

they are available in a variety of colours.

PROPERTIES OF DISTEMPERS :

Following are the properties of distempers:

- (i) On drying, the film of distemper shrinks. Hence it leads to cracking and flaking, if the surface to receive distemper is weak.
- (ii) The coatings of distemper are usually thick and they are more brittle than other types of water paints.
- (iii) The film developed by distemper is porous in character and it allows water vapour to pass through it. Hence it permits new walls to dry out without damaging the distemper film.
- (iv) They are generally light in colour and they provide a good reflective coating.
- (v) They are less durable than oil paints.
- (vi) They are treated as water paints and they are easy to apply.
- (vii) They can be applied on brickwork, cement plastered surface, lime plastered surface, insulating boards, etc.
- (viii) They exhibit poor workability.
- (ix) They prove to be unsatisfactory in damp locations such as kitchen, bathroom, etc.

INGREDIENTS OF A DISTEMPER :

A distemper is composed of base, carrier, colouring pigments and size. For base, the whiting or chalk is used and for carrier, the water is used. Thus it is more or less a paint in which whiting or chalk is used as base instead of white lead and the water is used as carrier instead of linseed oil.

The distempers are available in powder form or paste form. They are to be mixed with hot water before use. The oil-bound distempers are a variety of an oil paint in which the drying oil is so treated that it mixes with water. The emulsifying agent which is commonly used is glue or casein. As the water dries, the oil makes a hard surface which is washable.

It should be remembered that most of the manufacturers of ready made distemper supply complete directions for use of their products. These directions are to be strictly followed to achieve good results.

PROCESS OF DISTEMPER :

The application of distemper is carried out in the following way:

(1) **Preparation of surface:** The surface to receive the distemper is thoroughly rubbed and cleaned. The important facts to be kept in mind are:

- (i) The new plastered surfaces should be kept exposed for a period of two months or so to dry out before distemper is applied on them. The presence of dampness on the surface results in failure of distemper coating.

- (ii) The surface to receive distemper should be free from any efflorescence patches. These are to be wiped out by clean cloth.
- (iii) The irregularities such as cracks, holes, etc. of the surface are to be filled by lime putty or gypsum and allowed to become hard before distemper is applied on the surface.
- (iv) If distemper is to be applied on the existing distempered surfaces, the old distemper should be removed by profuse watering.

(2) **Priming coat:** After preparing the surface to receive the coats of distemper a priming coat is applied and it is allowed to become dry. For ready made distempers, the priming coat should be composed of materials as recommended by the makers of distempers. For local made distempers, the milk is used for priming coat. One litre of milk will cover about 10m^2 of the surface.

(3) **Coats of distemper:** The first coat of distemper is then applied on the surface. It should be of a light tint and applied with great care. The second coat of distemper is applied after the first coat has dried and become hard. Following facts are to be remembered:

- (i) The distemping should be done in dry weather to achieve better results.
- (ii) The oil-bound distemper or washable distemper adheres well to oil-painted walls, wood, corrugated iron, etc. But a priming coat of pure milk should be applied before distemping is done on such surfaces.
- (iii) The application of distemper by a spraying pistol is superior to that by brushes. The spraying affords smooth and durable film of distemper.

APPLICATION OF WHITEWASHING :

The fresh lime is slaked at site of work and mixed thoroughly with sufficient quantity of water in a tub. It is then screened through a clean cloth. The clean gum dissolved in hot water is then added at the rate of 20 N per m^3 of lime. The rice may be used in place of gum.

The surface to be whitewashed should be cleaned before the work is started. For whitewashing walls which are whitewashed before, the old loose whitewash is to be first removed and repairing to the plaster is carried out, if necessary. The whitewash is applied with jute brush and the brush is so worked that a surface with uniform colour is obtained. The three coats are generally applied, each after the previous coat has completely dried.

The lime is toxic for germs. It reflects light and thus it increases the brightness of the surface. The white washing therefore is extensively used for interior wall surface.

The process of whitewashing is sometimes used for exterior wall surfaces also. A satisfactory work gives an opaque smooth surface with uniform white colour and does not readily come off on the hand, when rubbed.

APPLICATION OF COLOURWASHING:

This is prepared by adding the colouring pigment to the screened whitewash. It should be seen that the colouring pigment is not affected by the presence of lime. Ordinarily, the yellow earth is popular for colour washing. Generally, the walls are

colour washed and ceilings are whitewashed. The mixture is to be kept constantly stirred during use.

The colourwash is applied in the same fashion as the whitewash. A satisfactory work does not give out powder when the finished surface is rubbed with the fingers.

The process of colour washing imparts cleanliness and pleasant appearance of the surfaces which are treated.

REPAINTING OF OLD SURFACE :

Repainting old woodwork: If the paint on the old woodwork has cracked or has developed blisters, it is to be removed. If the surface has become greasy, it should be cleaned by rubbing down sand-paper or fine pumice stone. The old paint can also be removed by applying anyone of the following three paint solvents.

(i) A solution containing 2 N of caustic soda to a litre of water is prepared and used to wash the surface. The paint dissolves and the surface becomes clean.

(ii) A mixture consisting of one part of soft soap and two parts of potash is prepared and one part of quicklime is then added afterwards. This mixture is applied on the surface in a hot state and allowed to stay for about 24 hours. The surface is then washed with hot water.

(iii) A mixture consisting of equal parts of washing soda and quicklime is brought to a paste form by adding required quantity of water. It is applied on the surface and kept for about an hour. The surface is then washed with water. After removing old paint from the surface, the woodwork is painted as in case of painting on new woodwork.

Repainting old ironwork and steelwork: The old surface should be thoroughly cleaned by the application of soap-water and if grease is present, it should be removed by washing the surface with lime and water. If it is necessary to remove old paint, the surface should be burnt, usually by a blow lamp and then old paint should be scraped off or dissolved and removed by using any paint solvent. After the surface is thus prepared, the painting is carried out as in case of new ironwork or steelwork.

CHAPTER-9

CAST IRON :

The cast iron is manufactured by re-melting pig-iron with coke and lime stone . This re-melting is done in a furnace known as the cupola furnace .

USES OF CAST IRON :

Following are the important uses of cast-iron:

- (i) For making cisterns, water pipes, gas pipes and sewers, manhole covers and sanitary fittings .
- (ii) For making ornamental castings such as brackets, gates, lamp posts, spiral staircases, etc.
- (iii) For making parts of machinery which are not subject to heavy shocks.
- (iv) For manufacturing compression members like columns in buildings, bases of columns, etc.
- (v) For preparing agricultural implements.
- (vi) For preparing rail chairs, carriage wheels, etc.

WROUGHT IRON :

The wrought iron is almost pure iron and it hardly contains carbon more than 0.15 percent or so . But the process of its manufacture is laborious and tedious .

USE OF WROUGHT-IRON :

The wrought-iron is replaced at present to a very great extent by mild steel. It is therefore produced to a very small extent at present. It is used where a tough material is required .

The wrought-iron, at present, is used for rivets, chains, ornamental iron work, railway couplings, water and steam pipes, raw material for manufacturing steel, bolts and nuts, horse shoe bars, handrails, straps for timber roof trusses, boiler tubes, roofing sheets, armatures, electro-magnets , etc .

STEEL:

Depending upon the carbon content, the steel is designated as the mild steel or medium carbon steel or high carbon steel. The various uses of steel are governed by the amount of carbon contained in it.

The carbon content of mild steel is about 0.10 to 0.25 per cent. When carbon content is less than 0.10 per cent, it is known as the dead steel or very low carbon steel.

The carbon content of medium carbon steel is about 0.25 to 0.60 per cent. The high carbon steel is also known as the hard steel and its carbon content varies from 0.60 to 1.10 per cent or so.

USES OF STEEL:

Name of steel	Carbon content	Uses
Mild steel plate, etc.	Up to 0.10%	Motor body ,Sheet metal ,tin
Medium carbon Steel	Up to 0.25%	Boiler plates , structural steel , etc.
	Up to 0.45%	Rails , tyres , etc.
pressing dies etc.	Up to 0.60%	Hammers ,large stamping and
High carbon steel stamping dies ,etc. Or hard steel	Up to 0.75%	Sledges hammers ,springs ,
mason's tools etc.	Up to 0.90%	Miner's drills,smith's tools,stone
working tools,etc.	Up to 1.00%	Chisels ,hammers ,saws,wood
Axes,Cutlery,drills,knives,picks,punches,etc.	Up to 1.10%	

It is observed that the steel is required for the existence of the heavy a light engineering industries, for ship building, railways and rolling stock, automobiles sheet metal industries, power generation and electrical industries, etc. It should also be noted that the entire range of electrical engineering industry depends upon the property of magnetism of steel.

PROPERTIES OF MILD STEEL

Following are the properties of mild steel:

- (i) It can be magnetised permanently.
- (ii) It can be readily forged and welded.
- (iii) It cannot be easily hardened and tempered.
- (iv) It has fibrous structure.
- (v) It is malleable and ductile.
- (vi) It is not easily attacked by salt water.
- (vii) It is tougher and more elastic than wrought-iron.
- (viii) It is used for all types of structural work.
- (ix) It rusts easily and rapidly.
- (x) Its melting point is about 1400°C.
- (xi) Its specific gravity is 7.80.

- (xii) Its ultimate compressive strength is about 80 to 120 kN per cm²
- (xiii) Its ultimate tensile and shear strengths are about 60 to 80 kN per cm²

PROPERTIES OF WROUGHT STEEL

Following are the properties of hard steel:

- (i) It can be easily hardened and tempered.
- (ii) It can be magnetised permanently.
- (iii) It cannot be readily forged and welded.
- (iv) It has granular structure.

CAST IRON :

The cast iron is manufactured by re-melting pig-iron with coke and lime stone . This re-melting is done in a furnace known as the cupola furnace .

USES OF CAST IRON :

Following are the important uses of cast-iron:

- (i) For making cisterns, water pipes, gas pipes and sewers, manhole covers and sanitary fittings .
- (ii) For making ornamental castings such as brackets, gates, lamp posts, spiral staircases, etc.
- (iii) For making parts of machinery which are not subject to heavy shocks.
- (iv) For manufacturing compression members like columns in buildings, bases of columns, etc.
- (v) For preparing agricultural implements.
- (vi) For preparing rail chairs, carriage wheels, etc.

WROUGHT IRON :

The wrought iron is almost pure iron and it hardly contains carbon more than 0.15 percent or so . But the process of its manufacture is laborious and tedious .

USE OF WROUGHT-IRON :

The wrought-iron is replaced at present to a very great extent by mild steel. It is therefore produced to a very small extent at present. It is used where a tough material is required .

The wrought-iron, at present, is used for rivets, chains, ornamental iron work, railway couplings, water and steam pipes, raw material for manufacturing steel, bolts and nuts, horse shoe bars, handrails, straps for timber roof trusses, boiler tubes, roofing sheets, armatures, electro-magnets , etc .

STEEL:

Depending upon the carbon content, the steel is designated as the mild steel or medium carbon steel or high carbon steel. The various uses of steel are governed by the amount of carbon contained in it.

The carbon content of mild steel is about 0.10 to 0.25 per cent. When carbon content is less than 0.10 per cent, it is known as the dead steel or very low carbon steel.

The carbon content of medium carbon steel is about 0.25 to 0.60 per cent. The high carbon steel is also known as the hard steel and its carbon content varies from 0.60 to 1.10 per cent or so.

USES OF STEEL:

Name of steel	Carbon content	Uses
Mild steel plate, etc.	Up to 0.10%	Motor body ,Sheet metal ,tin
Medium carbon Steel	Up to 0.25%	Boiler plates , structural steel , etc.
	Up to 0.45%	Rails , tyres , etc.
	Up to 0.60%	Hammers ,large stamping and pressing dies etc.
High carbon steel stamping dies ,etc. Or hard steel	Up to 0.75%	Sledges hammers ,springs ,
	Up to 0.90%	Miner's drills,smith's tools,stone
mason's tools etc.	Up to 1.00%	Chisels ,hammers ,saws,wood
working tools,etc.	Up to 1.10%	
Axes,Cutlery,drills,knives,picks,punches,etc.		

It is observed that the steel is required for the existence of the heavy a light engineering industries, for ship building, railways and rolling stock, automobiles sheet metal industries, power generation and electrical industries, etc. It should also be noted that the entire range of electrical engineering industry depends upon the property of magnetism of steel.

PROPERTIES OF MILD STEEL

Following are the properties of mild steel:

- (i) It can be magnetised permanently.
- (ii) It can be readily forged and welded.
- (iii) It cannot be easily hardened and tempered.
- (iv) It has fibrous structure.
- (v) It is malleable and ductile.
- (vi) It is not easily attacked by salt water.
- (vii) It is tougher and more elastic than wrought-iron.
- (viii) It is used for all types of structural work.

- (ix) It rusts easily and rapidly.
- (x) Its melting point is about 1400°C .
- (xi) Its specific gravity is 7.80.
- (xii) Its ultimate compressive strength is about 80 to 120 kN per cm^2
- (xiii) Its ultimate tensile and shear strengths are about 60 to 80 kN per cm^2

PROPERTIES OF WROUGHT STEEL

Following are the properties of hard steel:

- (i) It can be easily hardened and tempered.
- (ii) It can be magnetised permanently.
- (iii) It cannot be readily forged and welded.
- (iv) It has granular structure.

CHAPTER-10

BITUMINOUS MATERIALS

INTRODUCTION

Bituminous materials or asphalts are extensively used for roadway construction, primarily because of their excellent binding characteristics and water proofing properties and relatively low cost. Bituminous materials consists of bitumen which is a black or dark coloured solid or viscous cementitious substances consists chief high molecular weight hydrocarbons derived from distillation of petroleum or natural asphalt, has adhesive properties, and is soluble in carbon disulphide. Tars are residues from the destructive distillation of organic substances such as coal, wood, or petroleum and are temperature sensitive than bitumen. Bitumen will be dissolved in petroleum oils where unlike tar.

TYPES OF BITUMINOUS MATERIALS

Normally three types of bituminous materials are extensively used in civil engineering works. They are as follows.

Bitumen → It is the heavy end (i.e. higher molecular weight) residue from the fractionation of crude oil. It is a thick sticky black liquid obtained after extraction of things like fuels, fuel oils, lubricating oils and waxes from the crude oil.

Tar → It is similar to bitumen but is not extracted from crude oil. It is obtained from destructive distillation of organic materials like coal, wood etc.

Asphalt → It is a mixture of bitumen and aggregates (inorganic heavy fillers, sands, grit, stones) of various kinds used for construction of road surfaces.

Tar is no longer used for highway construction as it is considered to be a health hazard

COMPARISON BETWEEN BITUMEN, TAR & ASPHALT

Sl No	Property	Bitumen	Tar	Asphalt
1	Colour	Dark with slight reddish tinge	Deep Dark	Blackish brown
2	Carbon Content	Moderate	High	Low
3	State	Solid	Viscous Liquid	Solid or Semi-solid
4	Effect on Heating	Melts	Becomes more fluid	Burns with a smoke flame & becomes plastic
5	Setting Time	Less	More	Less
6	Adhesive Power	More	More	Less
7	Resistance to Acid	More	Less	More
8	Uses	As Damp Proof	For preserving	As damp proof

		Course & Roofing felt	Timber	course, for paints, as roofing felt & for road works
--	--	-----------------------	--------	--

TYPES OF TAR AND THEIR USE

Birch tar or birch pitch is a substance (liquid when heated) derived from the dry distillation of the bark of the birch tree.

Birch tar was used widely as an adhesive as early as the late Paleolithic or early Mesolithic era. It has also been used as a disinfectant, in leather dressing, and in medicine.

Coal tar is a brown or black liquid of extremely high viscosity. Coal tar is among the by-products when coal is carbonized to make coke or gasified to make coal gas. Coal tars are complex and variable mixtures of phenols, polycyclic aromatic hydrocarbons (PAHs), and heterocyclic compounds.

Coal tar is sometimes used for heating or to fire boilers as it is flammable. Coal tar was a component of the first sealed roads. Coal tar is also used to manufacture paints, synthetic dyes, and photographic materials.

Pine tar is a sticky material produced by the high temperature carbonization of pine wood in anoxic conditions (dry distillation or destructive distillation). The wood is rapidly decomposed by applying heat and pressure in a closed container; the primary resulting products are charcoal and pine tar.

Pine tar is now mainly used as a softening solvent in the rubber industry, and for construction material and special paints. Pine tar can be used for preserving wooden boats (and other wood which will be exposed to the elements) by using a mixture of pine tar, gum turpentine and boiled linseed oil

TYPES OF ASPHALT AND THEIR USE

Asphalt concrete pavement material is commonly composed of 5% asphalt/bitumen cement and 95% aggregates (stone, sand, and gravel). Due to its highly viscous nature, asphalt/bitumen cement must be heated so it can be mixed with the aggregates at the asphalt mixing plant.

Asphalt concrete paving is widely used in airports around the world. Due to the sturdiness and ability to be repaired quickly, it is widely used for runways dedicated to aircraft landing and taking off.

Mastic asphalt is a type of asphalt which differs from dense graded asphalt (asphalt concrete) in that it has a higher asphalt/bitumen (binder) content, usually around 7–10% of the whole aggregate mix, as opposed to rolled asphalt concrete, which has only around 5% added asphalt/bitumen.

Mastic asphalt being thermoplastic substance is widely used in the building industry for waterproofing flat roofs and tanking underground. Mastic asphalt is heated to a temperature of 210 °C (410 °F) and is spread in layers to form an impervious barrier about 20 millimeters (0.79 inches) thick.

Asphalt emulsion contain up to 70% asphalt/bitumen and typically less than 1.5% chemical additives. There are two main types of emulsions with different affinity for aggregates, cationic and anionic.

Asphalt emulsions are used in a wide variety of applications. Chipseal involves spraying the road surface with asphalt emulsion followed by a layer of crushed rock, gravel or crushed slag. Slurry seal involves the creation of a mixture of asphalt emulsion and fine crushed aggregate that is spread on the surface of a road. Cold-mixed asphalt can also be made from asphalt emulsion to create pavements similar to hot-mixed asphalt, several inches in depth and asphalt emulsions are also blended into recycled hot-mix asphalt to create low-cost pavements.

Other uses of Asphalt

Asphalt/bitumen is used to make Japan black, a lacquer known especially for its use on iron and steel. Asphalt/bitumen also is used in paint and marker inks by some graffiti supply companies (primarily Molotow) to increase the weather resistance and permanence of the paint and/or ink, and to make the color much darker. Asphalt/bitumen is also used to seal some alkaline batteries during the manufacturing process.

CHAPTER-11

PLASTICS, HEAT PROOFING AND ACOUSTIC MATERIALS

Plastic is the generic name for a family of synthetic materials derived from petrochemicals. It is often product of two or more components.

There are many families of plastics and polymers being used in construction industry. Examples of plastics used in building are: Acrylic, Composites, Expanded Polystyrene, Polycarbonate, Polyethylene, Polypropylene, Polyvinyl Chloride

Uses of Plastic as Building Materials

Some of the examples below are Products of Plastics in the Construction industry:

- Pipes : Electrical Conduits, Rain Water & Sewage pipes, Plumbing, Gas Distributions.
- Cables : PVC Insulation on cables, Insulation Tapes .
- Floorings : Flooring tiles & Rolls .
- Domes / sky lights : Opaque as well as transparent.
- Roofing : Coloured or Double skinned for insulation.
- Windows & doors : Extruded sections for Door and windows and panels.
- Storage tanks : Storage tanks.
- Hardware accessories : Washers, Nut bolts, Sleeves, Anchoring wires.
- Temporary structures: Guard cabins, tents
- Insulation materials: PVC sheets, insulating membranes.

Fireproofing or Heat proofing is rendering something ([structures](#), materials, etc.) proof against fire, or incombustible; or material for use in making anything fire-proof. It is a [passive fire protection](#) measure.

Characteristics of Fire Fighting/Resistant Materials

- The material used in building should be of such nature that it does not disintegrate under the effect of heat produced during fire.
- The material should not expand due to heat also and should ensure stability of structure.
- The nature of material used in building should have minimum contraction due to sudden cooling with water after the material is heated at high temperature.
- The nature of material used in the building should be such that it does not catch fire easily.

especially capable of stopping the critical low frequencies that are so hard to stop with less massive materials. Stone and brick are very similar to concrete in mass, and concrete masonry units, although they are lighter, can do a very good job when they are fully filled with concrete, instead of just filling the cells that contain the rebar.

Concrete slabs also do a good job of isolating sound between floors – something that is very difficult to do any other way.

Wood, and wood products:

Wood is much less dense than masonry, and provides much less in the way of sound isolation for that reason. Wood products like MDF, on the other hand, are somewhat more massive, and are sometimes used in interior walls to add mass. OSB is less dense than MDF, but can be useful as well, as part of an integrated system. Plywood comes in varying densities, and again can contribute something to the equation in a multi-layer wall.

Wood's real beauty lies in its ability to reflect sound in a pleasing way, meaning that it is a useful material for sound treatment. Since wood resonates easily, it has a way of absorbing some of the sound energy as it vibrates, letting some of the sound pass through to the other side, and reflecting some of the sound back from whence it came. This genteel quality of wood is one reason it is widely used in the making of musical instruments, and wood has a major role to play as an interior finish material in good sounding rooms.

Steel:

Steel is a quite dense material, but because of its expense it is rarely used as a sound isolation material. Steel's density actually becomes a liability in structural uses where its dense nature causes it to carry sound vibrations for long distances. If you strike an I-beam with a hammer and place your ear to the other end –let's say 24 ft. away, you'll see that the sound carries quite well through the steel. This type of sound transfer is called *structure-borne vibration*, where sound is carried through some material other than air for a time. The other main type of sound transfer is *air-borne vibration*.

Steel studs can actually transmit less structure-borne vibration than wood, even though steel is more prone to this problem simply because flimsy steel studs have much less cross-sectional area to carry the vibrations between the two wall surfaces.

Drywall and plaster:

Drywall is the poor man's masonry, and for interior walls can provide a lot of mass for the money. But one ½" layer doesn't do all that much. Multiple layers are used in sound studios and broadcast facilities where high mass walls are needed.

Roofing:

Asphalt shingles are fairly massive, as you know if you hauled them up to the roof, but they are also thin. Installation with a large overlap, heavy felt, and even double layer sheathing can

help quite a bit. Ceramic and clay tiles are more massive than wood shakes by far, and can do a reasonable job in residential applications. Metal roofing has mass but is thin, and requires that the underlying structure be fairly massive.

Glass and other transparent materials:

Glass is quite massive – about three times as massive as drywall. So in a sound wall with three 5/8” layers of drywall on one side, one layer of 5/8” glass maybe inserted to create a window *on that side*, provided that it is properly sealed. A corresponding piece of glass would be required on the other side of the wall, at the appropriate thickness.

A relatively recent development is the invention of absorptive glass-like products that offer pretty good transparency while absorbing enough sound to reduce the harsh reflectivity usually associated with glass. These products are made from Plexiglas or thin transparent foils, perforated with tiny holes. Their use is mainly confined to professional sound studios.

Insulating materials (fiberglass, foam, rock wool, etc.):

Insulating materials have little mass, so they have limited uses for sound isolation. However, fiberglass has good sound *absorption* characteristics, and is very useful as a sound treatment material for sound room interiors. Fiberglass and rock wool, which has similar acoustic properties, absorb sound by slowing the *velocity* of the air particles carrying the wave. Wood, on the other hand, absorbs sound best when in the *pressure zone* of a sound wave. Sound waves are at highest pressure when at lowest velocity, so care must be taken to place materials appropriately. Waves are generally at highest pressure at room boundaries, particularly multiple boundaries like dihedral and trihedral corners.

Plastics and Rubber (vinyl, neoprene):

Plastics are sometimes used in the manufacture of low-cost acoustical devices, but have limited usefulness. Rubber, particularly neoprene rubber is very good as a mechanical isolator -- for floating glass and preventing the diaphragmatic vibrations of the glass from transmitting into the wall, for instance.

Mass loaded vinyl can be used inside wall cavities to increase sound isolation, and is hung in a limp, as opposed to stretched, fashion.

Mechanical and plumbing materials (ductwork, metal and plastic pipes):

Metal and plastic pipes are often transmitters of structure borne vibration, and can be isolated or deadened with rubber materials. Refrigerant lines are especially bad for transmitting high-pitched whining noises through buildings, so you want to locate them carefully, and decouple them from the structure.

Ductwork should be heavy sheet metal, lined with at least 1” of acoustic liner. Flex duct is virtually acoustically transparent, and should be avoided when you are picky about crosstalk between the ducts in attics and other mechanical spaces.

Fabrics and other soft materials:

Fabrics, carpets, and other soft materials can be useful for sound treatment. Heavy stage type curtains are much more effective than thin fabrics. Carpets, although sometimes better than nothing, can soak up too much mid and high frequency sound while leaving boomy lower frequencies untreated. As part of an overall plan, carpet can be put to good use, but area rugs are much more versatile and adjustable.

Specialty acoustical products:

Specialty products generally fall into two categories: those used for sound isolation, and those used for acoustical treatment. Those used for sound isolation include various shock absorbers used to isolate air handlers and ductwork, and even to float concrete slabs, as well as neoprene isolators used for floating drywall off of studs (in conjunction with metal furring channel). Specialized door seals also utilize neoprene, and the best ones are adjustable, so that the installer can tweak any gaps between the door and the neoprene. Neoprene is also used under floor plates to isolate walls from floors. When specifying neoprene, care must be taken to get the proper *durometer*, or firmness, of neoprene, so that it doesn't bottom out and cease to work as a shock absorber. Sound deadening board can be used between layers of drywall, or between the drywall and the studs, to reduce structure borne vibration while also deadening resonances.